

FEATURES AND APPLICATIONS

- Power LED Driver
- Constant Current Output ($\pm 7\%$ Output Current Accuracy)
- Wide Input Voltage Range: 7V to 30V (40V for 0.5 sec)
- 16 Pin DIL Package
- LED Driver Current up to 700mA
- Output Power up to 20W
- Driver LED Strings of up to 28V (2V to 28V)
- RoHS ✓
- High Efficiency (up to 95%)
- PWM/Digital Dimming and Analog Voltage Dimming
- Open and Short LED Protection
- -40°C to 85°C Operation Temperature Range



- 12V and 24V Lighting Systems
- Household/Commercial lighting
- Suitable for high illumination LED
- Battery lighting systems

GENERAL DESCRIPTION

The VLD-V30C700 is a high efficiency step-down converter optimized to drive high current LEDs. The control algorithm allows highly efficient and accurate LED current regulation. The device operates from an input of 7Vdc to 30Vdc and provides an externally adjustable output current of up to 700mA and output power up to 20 Watts. Compact size of DIL16 allows designer to integrate this driver together with LED module.

DIL 16 Package

Notes : All dimensions are typical in millimeters (inches).

1. Pin diameter: 0.5 ± 0.05 (0.02 ± 0.002)
2. Pin pitch tolerance: ± 0.35 (± 0.014)
3. Case Tolerance: ± 0.5 (± 0.02)

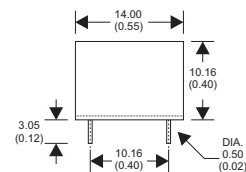
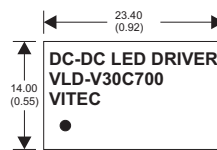

VLD-V30C700		
Pin	Connections	Note
1, 2	-V Input	-DC Supply
3	V adj	PWM/on/off or not used
7, 8	-V Output	LED Cathode Connection
9, 10	+V Output	LED Anode Connection
15, 16	+V Input	+DC Supply

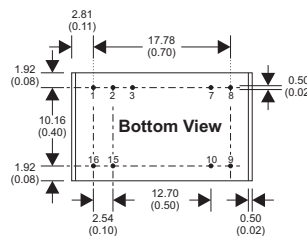

Recommended Footprint Details

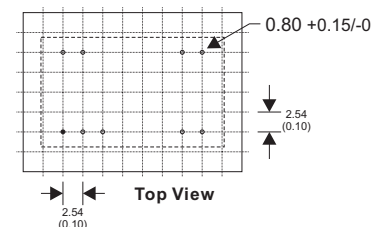

No connection is allowed between input and output

Notes:

Specifications can be changed without prior notice

Products are not intended for and must not be used in life support systems, human implantation, nuclear facilities or systems or any other application where product failure or malfunction of the component could lead to loss of life or catastrophic property damage

ELECTRICAL SPECIFICATIONS

Specifications typical at +25°C, nominal Input voltage, rated output current unless otherwise specified.

Input Specifications

Voltage Range	7Vdc to 30Vdc (40V for 0.5 sec)
Filter	Capacitor

Output Specifications

Voltage Range	2Vdc to 28V (Vin = 30Vdc)
Current Range	700mA (Vin - Vout > 2V to 3V)
Current Accuracy	±7% (Iout = 700mA)
Ripple and Noise (20 MHz BW)	250 mVp-p, max.
Short Circuit Protection	Regulated at Rated Output Current
Capacitive Load	47µF

Environmental Specification

Operating Temperature	-40°C to +85°C
Max. Case Temperature	+100°C
Storage Temperature	-40°C to +125°C
Thermal Impedance	+50°C/W (Nature Convection)
Cooling	Free-air convection
Temperature Coefficient	±0.05%/°C max. (Ta = -40°C to +85°C)

Analog Dimming Control

Leave Open if Not Used	
Vadj Input Voltage Range	0.3V to 1.25V
Adjust Output Current	25% to 100%
Control Voltage Range Limits	
On	0.2V to 0.3V
Off	0.15V to 0.25V
Analog Pin Drive Current	< 1mA (Vadj = 1.25V)

PWM Dimming and On/Off Control

Leave Open if Not Used	
Remote On/Off	
DC/DC On	Open or 0.3V < Vadj < 1.25V
DC/DC off (Shutdown)	Vadj < 0.15V
Remote Pin Drive Current	< 1mA (Vadj = 1.25V)
Quiescent Input Current in Shutdown Mode	25µA (max, Vin = 30V)
PWM Dimming	
Recommended Maximum Operating Frequency	1kHz
Minimum Switch ON Time	200ns
Minimum Switch OFF Time	200ns

General Specification

Efficiency	95% max. (Full Load)
Switching Frequency	55 kHz to 320 kHz
Humidity	95% rel H
MTBF (MIL-HDBK-217 F)	> 4.7 Mhrs

Physical Characteristics

Dimension DIP	23.40 x 14.00 x 10.16 mm 0.92 x 0.55 x 0.40 inches
Weight	6.2 g
Case Material	Non-Conductive Black Plastic (UL94-V0 rated)
Potting Material	Epoxy (UL94-V0 rated)
Pin Material	∅ 0.5mm Brass Solder-coated
Soldering Temperature	+260°C (1.5mm from case 10 sec.)

Notes

1. Reversed power source damages the circuit, No connection is allowed between input ground and output .
2. DO NOT operate the driver over 20W output.
3. Leave pin VADJ open if not in use, ground pin to shut down the converter. Connecting Vadj to Vin damages the circuit.
4. Maximum output open voltage is equal to input voltage.

Typical Operating Conditions

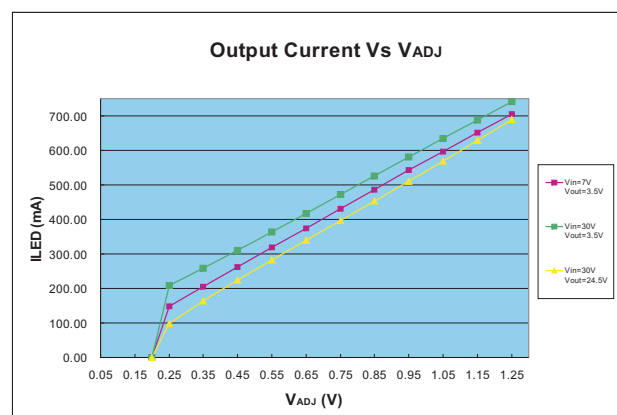
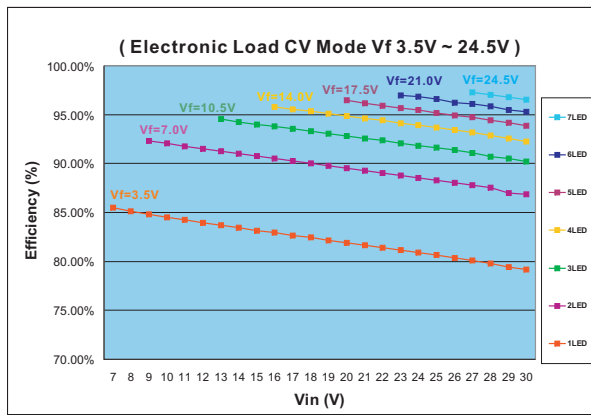
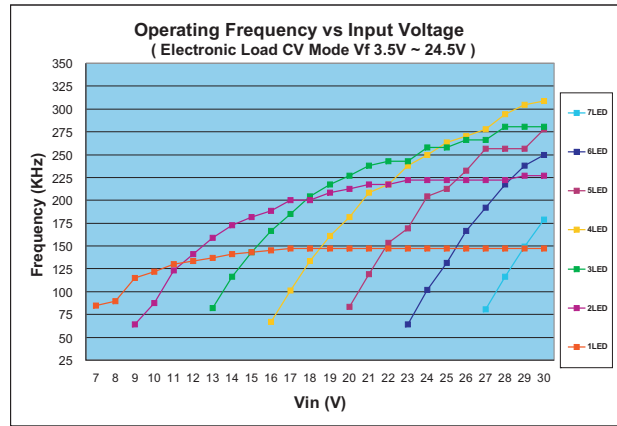
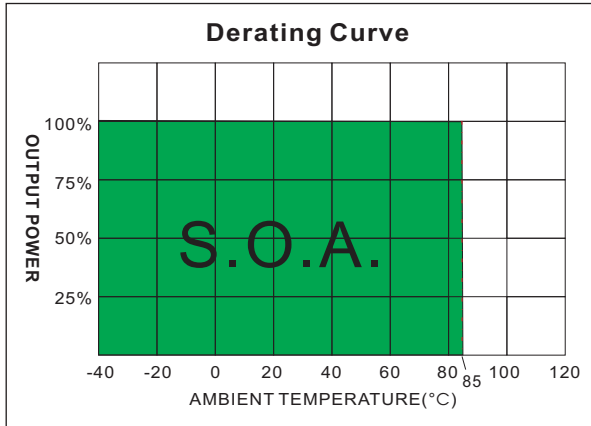

Recommended additional input filter

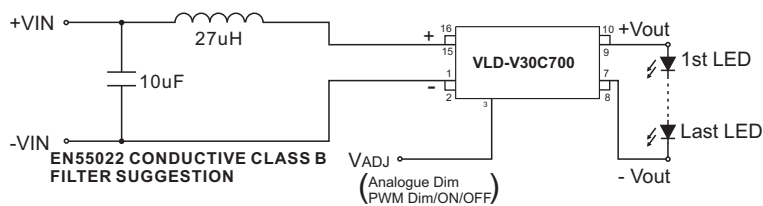

Vin=30V Vout=27V (Electronic Load CV Mode Vf 27V)

Vin=12V Vout=7V (Electronic Load CV Mode Vf 7V)

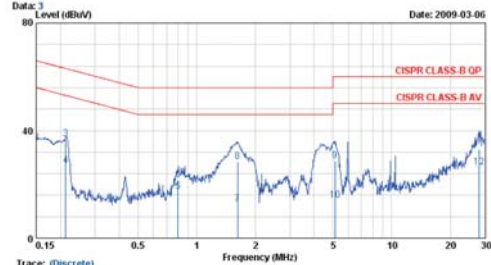
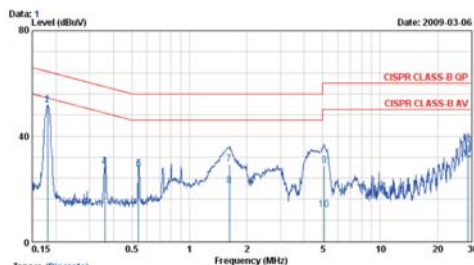

Trace: (Discrete)	Freq. MHz	L12M dB	Cable dB	Meter Reading dBuV	Measured dBuV	Limits dBuV	Over dBuV	Detector
0.181	9.80	0.06	41.79	51.65	64.46	12.81	12.81	OP
0.181	9.80	0.06	42.05	51.91	54.46	-2.55	-2.55	AVERAGE
0.361	9.89	0.05	18.42	28.56	58.71	130.15	130.15	OP
0.361	9.89	0.05	18.57	28.51	48.71	-20.20	-20.20	AVERAGE
0.541	9.90	0.05	17.59	27.54	56.00	128.46	128.46	OP
0.541	9.90	0.05	17.44	27.39	46.00	-18.61	-18.61	AVERAGE
1.624	9.97	0.05	19.24	29.26	56.00	126.74	126.74	OP
1.624	9.97	0.05	11.10	21.12	46.00	-24.88	-24.88	AVERAGE
2.085	9.83	0.25	18.53	28.61	60.00	131.39	131.39	OP
2.085	9.83	0.25	1.96	12.04	50.00	137.96	137.96	AVERAGE
25.908	110.06	0.31	26.29	36.68	60.00	123.32	123.32	OP
25.908	110.06	0.31	20.64	31.03	50.00	118.97	118.97	AVERAGE

Trace: (Discrete)	Freq. MHz	L12M dB	Cable dB	Meter Reading dBuV	Measured dBuV	Limits dBuV	Over dBuV	Detector
0.150	9.80	0.07	17.57	27.44	56.00	-28.56	-28.56	AVERAGE
0.150	9.80	0.07	25.61	35.48	66.00	-30.52	-30.52	OP
0.213	9.81	0.05	26.98	36.84	63.10	-26.26	-26.26	OP
0.213	9.81	0.05	17.10	26.96	53.10	-26.14	-26.14	AVERAGE
0.801	9.90	0.04	7.33	17.27	46.00	-28.73	-28.73	AVERAGE
0.801	9.90	0.04	11.62	21.56	56.00	-34.44	-34.44	OP
1.619	9.97	0.05	2.66	12.68	46.00	-33.32	-33.32	OP
1.619	9.97	0.05	18.55	28.57	56.00	-27.43	-27.43	OP
2.112	9.83	0.26	18.54	28.62	60.00	-31.38	-31.38	OP
2.112	9.83	0.26	4.09	14.17	50.00	-35.83	-35.83	AVERAGE
25.003	110.06	0.38	22.77	33.21	60.00	-26.79	-26.79	OP
25.003	110.06	0.38	15.86	26.30	50.00	-23.70	-23.70	AVERAGE

REMARKS: 1.Level(dBuV)-Read Level(dBuV)+L12M Factor(dB)+Cable loss(dB)
2.Over: Limit value(dB)-Level(dBuV)-Limit Line(dBuV)

REMARKS: 1.Level(dBuV)-Read Level(dBuV)+L12M Factor(dB)+Cable loss(dB)
2.Over: Limit value(dB)-Level(dBuV)-Limit Line(dBuV)

Typical Application

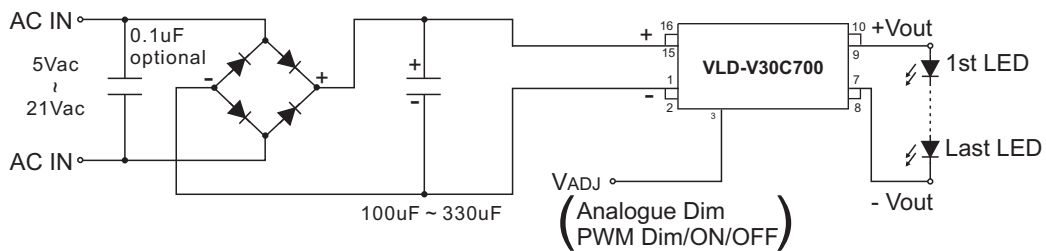
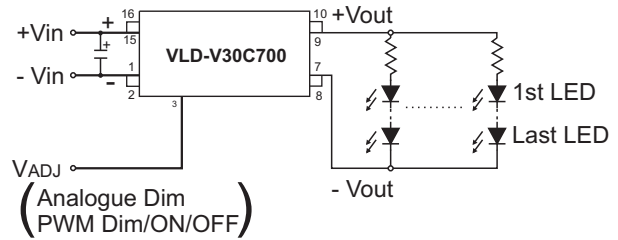
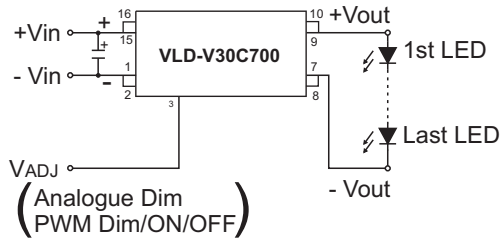

Output Current Adjustment By External DC Control Voltage

The nominal output current is then given by:

$$I_{out} \approx \frac{0.08 \times V_{ADJ}}{0.1388}$$

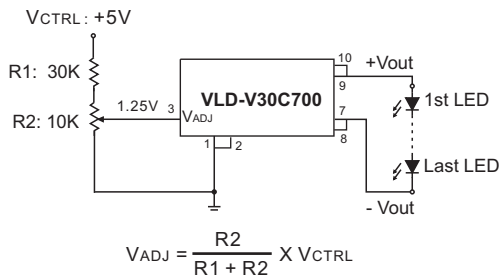
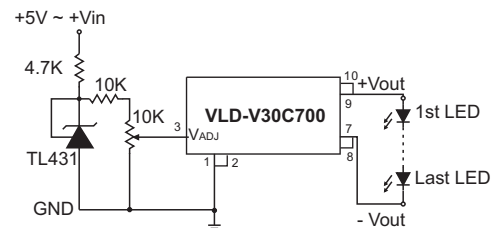
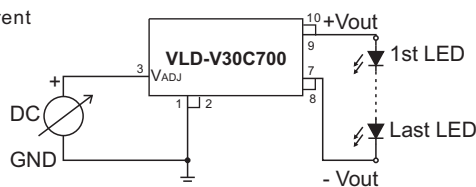

Resistor dimming

By connecting a variable resistor between ADJ and GND, simple dimming can be achieved. Capacitor C_{ADJ} is optional for better AC mains interference and HF noise rejection. Recommend value of C_{ADJ} is 0.22uF.

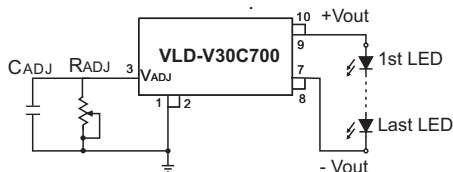

The current output can be determined using the equation:

$$I_{out} = \frac{(0.08 / 0.1388) \times R_{ADJ}}{(R_{ADJ} + 200K)}$$

Typical Application

Output Current Adjustment By PWM Control

Directly driving ADJ input

A Pulse Width Modulated (PWM) signal with duty cycle DP_{PWM} can be applied to the ADJ pin, as shown below

$$I_{out} \approx \frac{0.1 DP_{PWM}}{0.1388} \quad [\text{for } 0 < DP_{PWM} < 1]$$

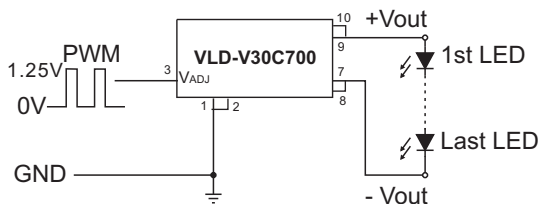

Driving the ADJ input via open collector transistor

The diode and resistor suppress possible high amplitude negative spikes on the ADJ input resulting from the drain-source capacitance of the transistor. Negative spikes at the input to the device should be avoided as they may cause errors in output current, or erratic device operation.

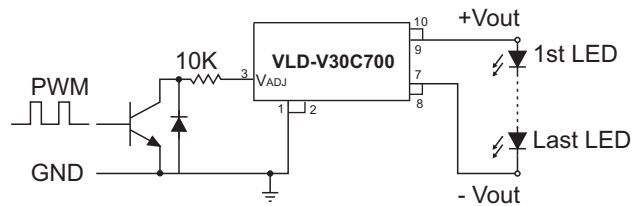

Driving the ADJ input from a microcontroller

Another possibility is to drive the device from the open drain output of a microcontroller. The diagram below shows one method of doing this:

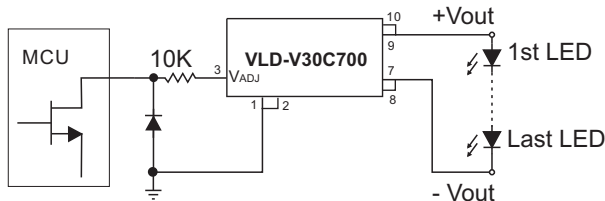

The diode and resistor suppress possible high amplitude negative spikes on the ADJ input resulting from the drain-source capacitance of the FET. Negative spikes at the input to the device should be avoided as they may cause errors in output current, or erratic device operation.

Output Current Adjustment By PWM Control (Dimming)

To avoid visible flicker the PWM signal must be greater than 100Hz.

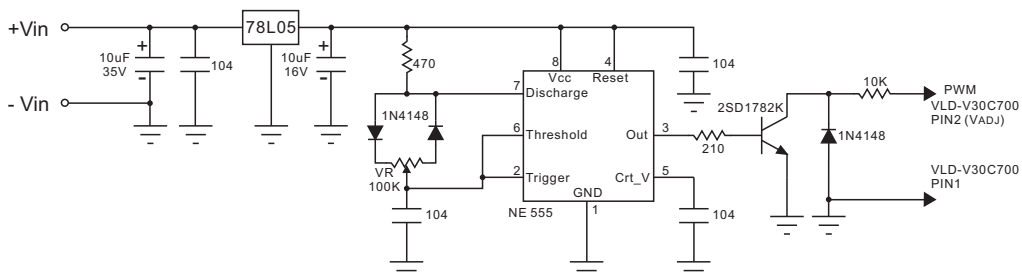

Output Current Adjustment By PWM Control (Flash)

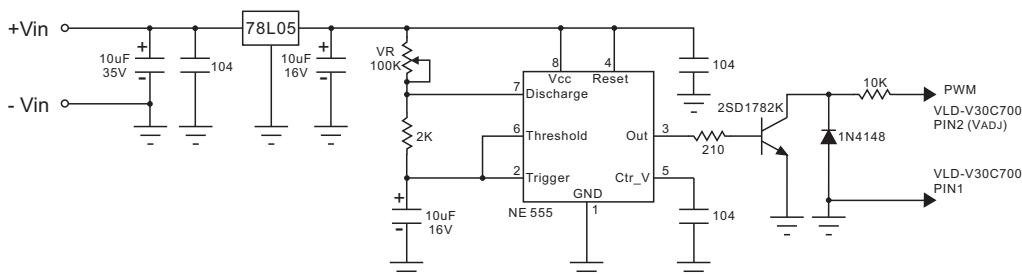

Typical Application

Output Current Adjustment By External DC Control Voltage

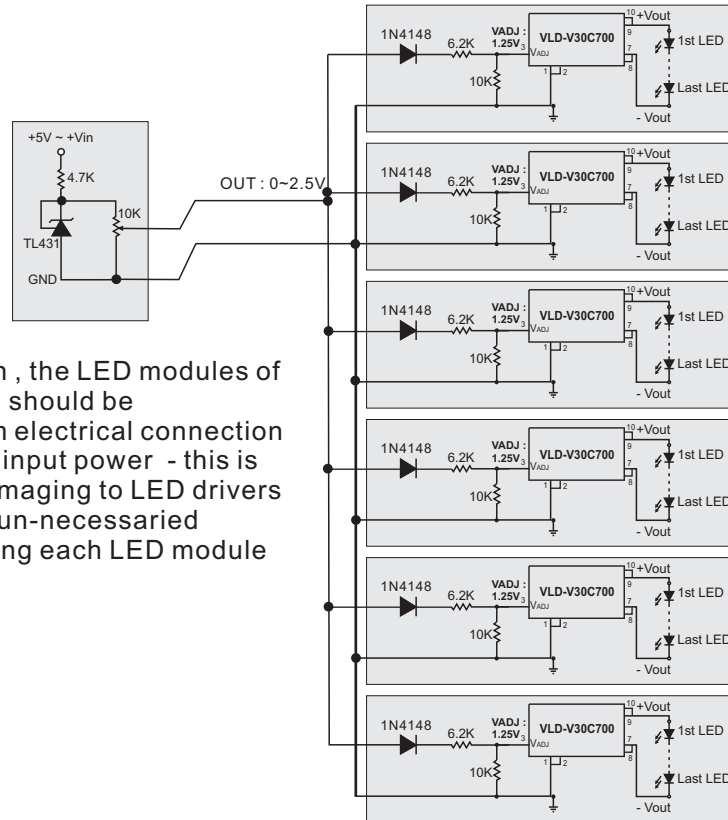

In this application, the LED modules of each LED drivers should be independent from electrical connection to the others and input power - this is to prevent the damaging to LED drivers also to avoid the un-necessary interference among each LED module

Thermal feedback circuit

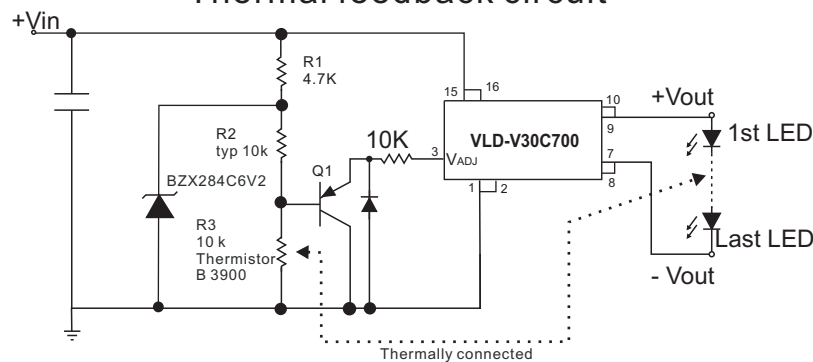

The selection of components for the thermal feedback circuit is not only dependent on the choice of R2 and R3, but also on the amount of heat sink area required to extract heat from the LEDs. To maximize the light output at high ambient or operating temperature conditions, the LEDs must have a sufficient thermal extraction path, otherwise the thermal control circuit will effect current drive reduction in non-optimal conditions. The thermal control threshold point is set by adjusting R2. For this design, three values (33k, 22k and 10k) were evaluated. These values were chosen to give break points at approximately 25°C, 40°C and 60°C. Note that the light output will not continually dim to zero - the thermal control is applying DC control to the ADJ pin and therefore has a dimming ratio from maximum Current of approximately 5:1. Once the reduced DC level goes below the shutdown threshold of around 200mV, the LED drive current will fall to zero and the LEDs will be extinguished. The slope of the current reduction is determined by the beta value of the thermistor. The larger the beta value, the sharper will be the resultant current control response. The slope of the current reduction is also affected by Q1's base emitter voltage (VBE) variation with temperature.