

RACKS

4 Channel

FEATURES

- Use for Isolating and Coverting Signal Types to Standard Logic Voltages
- Terminal Block Connection for Input and Output
- Available for Standard and G5 I/O Modules
- Panel and DIN Rail Mount Versions
- UL, CSA Certified



4 CHANNEL RACK: Standard

Part No. 70RCK4

Dimensions are shown in inches (and millimeters). All tolerances are ± 0.010 (0,25) unless otherwise specified.

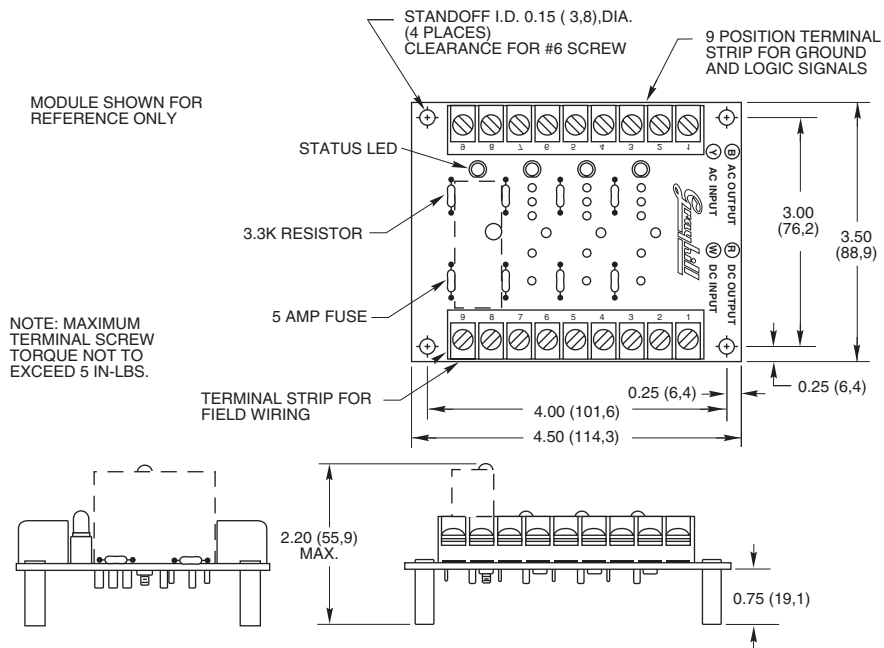

4 CHANNEL RACK: G5

Part No. 70GRCK4

Dimensions are shown in inches (and millimeters). All tolerances are ± 0.010 (0,25) unless otherwise specified.

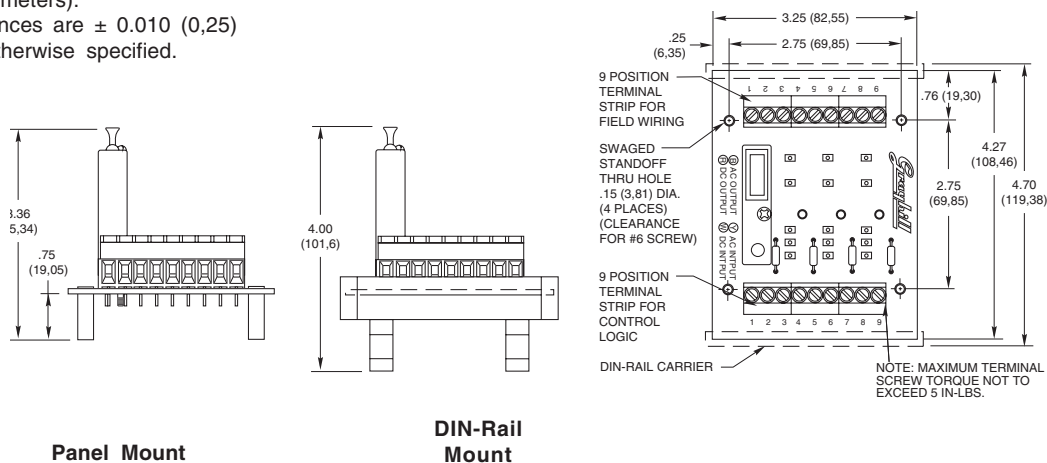

Panel Mount

DIN-Rail Mount

SCHEMATICS: Part No. 70RCK4

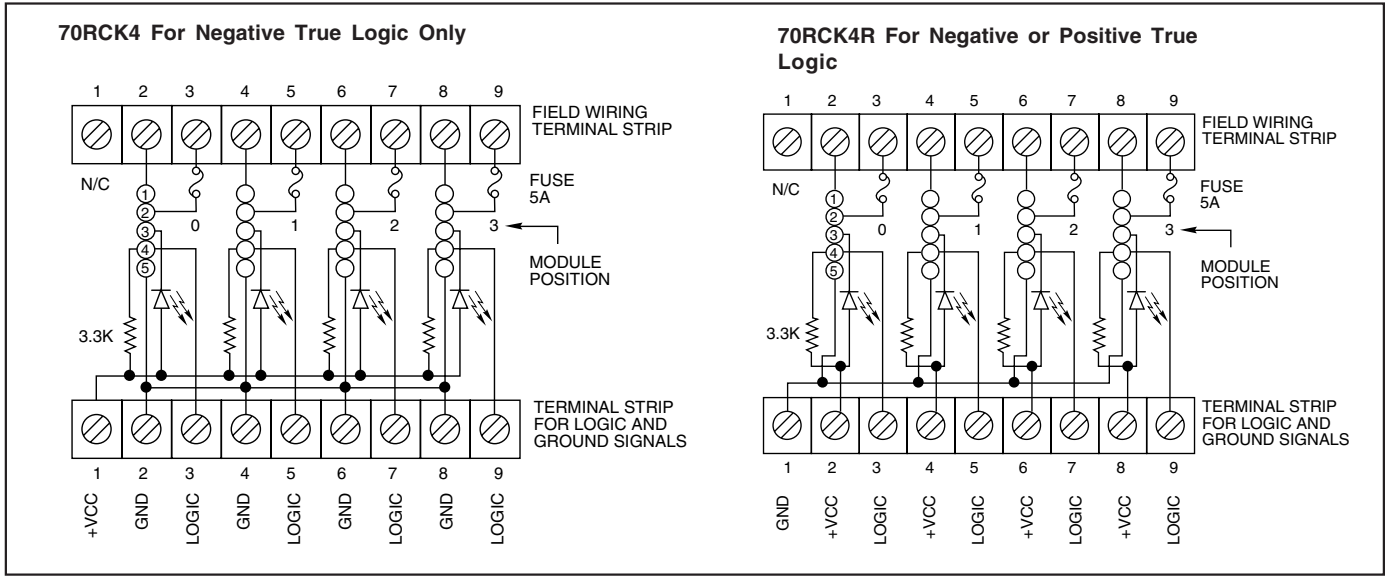

SCHEMATICS: Part No. 70GRCK4

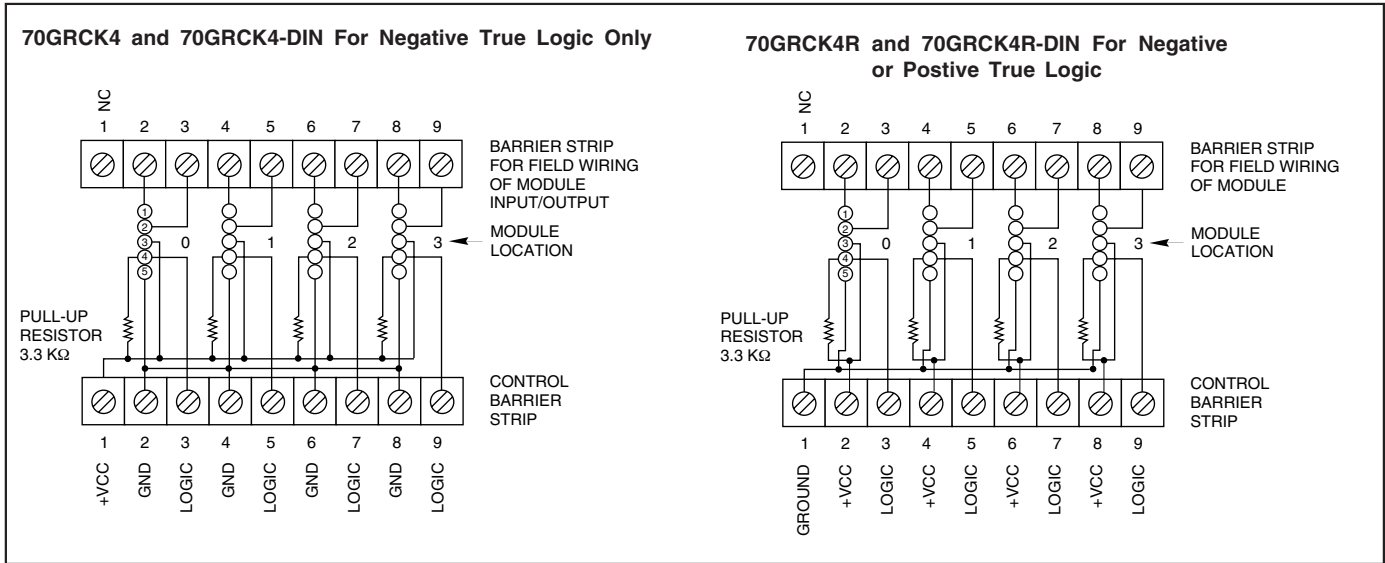

ORDERING INFORMATION (modules ordered separately)

Part Number	I/O	Description	UL	CSA	Style
70RCK4	4	Negative true logic	X	X	Standard
70RCK4R	4	Positive or negative true logic*	X	X	Standard
70GRCK4	4	Negative true logic	X	X	G5
70GRCK4R	4	Positive or negative true logic*	X	X	G5
70GRCK4-DIN	4	Negative true logic— <i>DIN rail mount</i>	X	X	G5
70GRCK4R-DIN	4	Positive or negative true logic*— <i>DIN rail mount</i>	X	X	G5

Available from your local Grayhill Distributor. For prices and discounts, contact a local Sales Office, an authorized local Distributor, or Grayhill.

*Note: Positive True Logic applies to output modules only.

ACCESSORIES

CABLE ASSEMBLIES

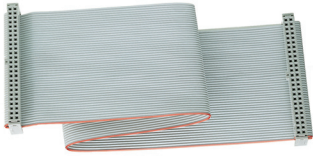

Several standard cable assemblies to connect controllers to our I/O module mounting racks may be ordered. The 72-CHH cable has a 50-pin header connector on each end to mate with those on mounting racks. The 72-CHE cable has a 50-pin header connector on one end and a 50-pin edge card connector on the other.

ORDERING INFORMATION

Part Number	Description
Cable Assemblies	
72-CHH-1	Ribbon cable assembly, header to header, 1 foot long
72-CHH-2	Ribbon cable assembly, header to header, 2 feet long
72-CHH-4	Ribbon cable assembly, header to header, 4 feet long
72-CHH-6	Ribbon cable assembly, header to header, 6 feet long
72-CHE-2	Ribbon cable assembly, header to edge card, 2 feet long
72-CHE-4	Ribbon cable assembly, header to edge card, 4 feet long
72-CHE-6	Ribbon cable assembly, header to edge card, 6 feet long

I/O Modules, Module Racks, and Accessories are available through Authorized Grayhill Industrial Distributors. For prices and discounts, contact your local sales office, an authorized Industrial Distributor, or Grayhill.