



CFB600W-110S CMFD Series Application Note V12

ISOLATED DC-DC CONVERTER CHASSIS MOUNT CFB600W-110S CMFD SERIES APPLICATION NOTE



Approved By:

Department	Approved By	Checked By	Written By
Research and Development Department	Enoch	Hugo/Sam	Joyce
Design Quality Department	Benny	JoJo	



CFB600W-110S CMFD Series

Application Note V12

Contents

1. Introduction	3
2. Pin Function Description	3
3. Terminal Block	4
4. Connection for standard use	5
5. Test Set-Up	5
6. Features and Functions	5
6.1 UVLO (Under Voltage Lock Out)	5
6.2 Over Current/Short Circuit Protection	6
6.3 Output Over Voltage Protection	6
6.4 Over Temperature Protection	6
6.5 Remote On/Off	6
6.6 Output Remote Sensing	7
6.7 Output Voltage Adjustment	7
6-7.1 Output Voltage Trim Range($\pm 10\%$)	7
6-7.2 Output Voltage Trim Range(-40%, +10%)	7
6.8 IOG Signal	8
6.9 Auxiliary Power for Output Signal	8
7. Input / Output Considerations	8
7.1 Hold up Time	8
7.2 Output Ripple and Noise	9
7.3 Output Capacitance	9
8. Series and Parallel Operation	9
8.1 Series Operation	9
8.2 Parallel/Redundant Operation	10
9. Thermal Design	11
9.1 Operating Temperature Range	11
9.2 Convection Requirements for Cooling	11
9.3 Thermal Considerations	11
9.4 Power Derating	11
9.5 Heat Sink	15
10. Safety & EMC	16
10.1 Input Fusing and Safety Considerations	16
10.2 EMC Considerations	16



CFB600W-110S CMFD Series

Application Note V12

1. Introduction

The CFB600W-110SXX-CMFD series of chassis mountable DC-DC converters offers 600watts of output power @ single output voltages of 12, 24, 28, 48VDC. It has a wide (4:1) input voltage range of 43 to 160VDC (110VDC nominal) and 2250VDC basic isolation.

High efficiency up to 88%, allowing case operating temperature range of -40°C to 100°C. An external heatsink is required to expand the full power range of the product. Very low no load power consumption (25mA), an ideal solution for energy critical systems.

Built-in EMI EN50155, EN50121-3-2 filter. Meet EN45545. The standard control functions include remote on/off (positive or negative) and +10%, -40% adjustable output voltage.

Fully protected against input UVLO (under voltage lock out), output over-current, output over-voltage and over-temperature and continuous short circuit conditions.

CFB600W-110SXX-CMFD series is designed primarily for common railway applications of 72V, 96V, 110V nominal voltage and also suitable for distributed power architectures, telecommunications, battery operated equipment and industrial applications.

2. Pin Function Description

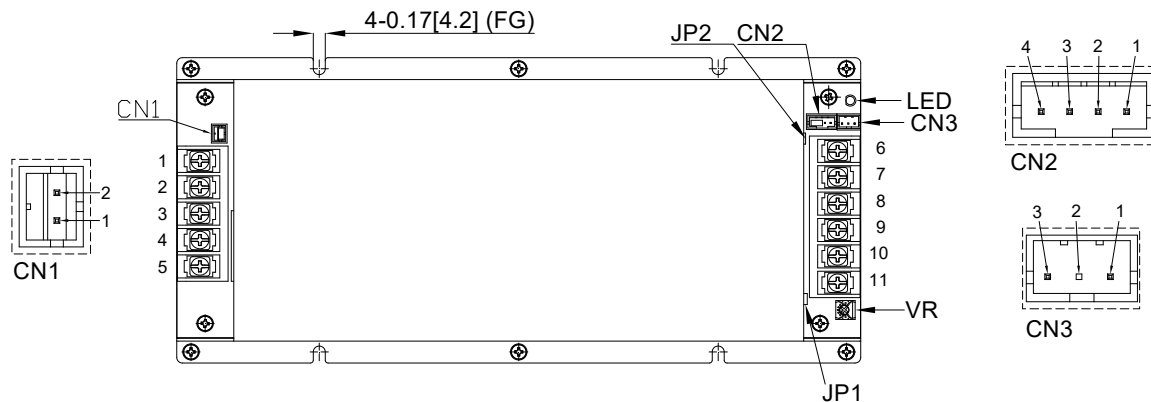

No		Description	Reference
1	PE	Connected to Base Plate	--
2	-V Input	Negative Supply Input	Section 7.1
3	-V Input	Negative Supply Input	Section 7.1
4	+V Input	Positive Supply Input	Section 7.1
5	+V Input	Positive Supply Input	Section 7.1
6	-V Output	Negative Power Output	Section 7.2/7.3
7	-V Output	Negative Power Output	Section 7.2/7.3
8	-V Output	Negative Power Output	Section 7.2/7.3
9	+V Output	Positive Power Output	Section 7.2/7.3
10	+V Output	Positive Power Output	Section 7.2/7.3
11	+V Output	Positive Power Output	Section 7.2/7.3
--	--	Clear Mounting Insert (FG)	--
	JP1	Short +S & +Vo	Section 6.6/ Section 6-7.2
	JP2	Short -S & -Vo	Section 6.6/ Section 6-7.2



CFB600W-110S CMFD Series Application Note V12

No	CN1	Description	Reference
1	-V Input	Negative Supply Input	Section 6.5
2	-On/Off	External Remote On/Off Control	

No	CN2	Description	Reference
1	-Sense	Negative Output Remote Sense	Section 6.6
2	+Sense	Positive Output Remote Sense	Section 6.6
3	Trim	External Output Voltage Adjustment	Section 6.7
4	Rt		

No	CN3	Description	Reference
1	AUX	Auxiliary Power for Output	Section 6.9
2	IOG	Inverter Operation Good Signal	Section 6.8
3	PC	Parallel Operation Control	Section 8.2

Note: Base plate can be connected to FG through Ø4.2 mounting insert. Recommended torque 8Kgf-cm.

3. Terminal Block

Input and Output Terminal Block

Terminal Type	Screw Torque Value (Kgf-cm)	Suitable Electric Wire (AWG)	Current Rating (max.)
DT-49-B01W-xx or Equivalent	10	12-22	25A



CFB600W-110S CMFD Series Application Note V12

4. Connection for standard use

The connection for standard use is shown below. An external output capacitor (C1) is recommended to reduce output ripple and noise, output capacitor recommended 1uF ceramic capacitor.

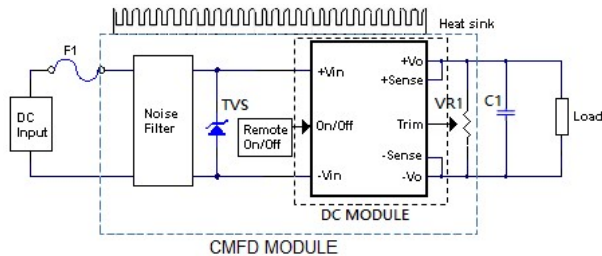

Symbol	Component	Reference
F1	Input fuse	Section 10.1
Noise Filter	Internal input noise filter	Section 10.2
Remote On/Off	External Remote On/Off control	Section 6.5
Trim	Internal output voltage adjustment by variable resistor	Section 6.7
Heat Sink	External heat sink	Section 9.4/9.5
+Sense/-Sense	--	Section 6.6

5. Test Set-Up

The basic test set-up to measure parameters such as efficiency and load regulation is shown below. When testing the modules under any transient conditions please ensure that the transient response of the source is sufficient to power the equipment under test. We can calculate:

- Efficiency
- Load regulation and line regulation

The value of efficiency is defined as:

$$\eta = \frac{V_o \times I_o}{V_{in} \times I_{in}} \times 100\%$$

Where:

- V_o is output voltage,
- I_o is output current,
- V_{in} is input voltage,
- I_{in} is input current

The value of load regulation is defined as:

$$Load.reg = \frac{V_{FL} - V_{NL}}{V_{NL}} \times 100\%$$

Where:

V_{FL} is the output voltage at full load

V_{NL} is the output voltage at no load

The value of line regulation is defined as:

$$Line.reg = \frac{V_{HL} - V_{LL}}{V_{LL}} \times 100\%$$

Where:

V_{HL} is the output voltage of maximum input voltage at full load

V_{LL} is the output voltage of minimum input voltage at full load.

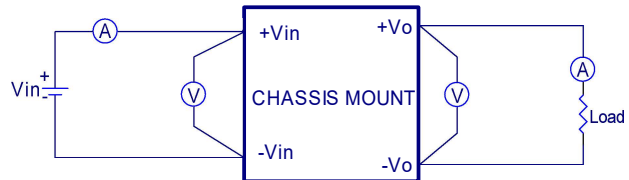

CFB600W-110SXX-CMFD Series Test Setup

6. Features and Functions

6.1 UVLO (Under Voltage Lock Out)

Input under voltage lockout is standard on the CFB600W-110SXX-CMFD unit. The unit will shut down when the input voltage drops below a threshold, and the unit will operate when the input voltage goes above the upper threshold.



CFB600W-110S CMFD Series

Application Note V12

6.2 Over Current/Short Circuit Protection

All models have internal over current and continuous short circuit protection. At the instance of current-limit inception, the module enters a constant current mode of operation. While the fault condition exists, the module will remain in this constant current mode, and can remain in this mode until the fault is cleared. The unit operates normally once the output current is reduced back into its specified range.

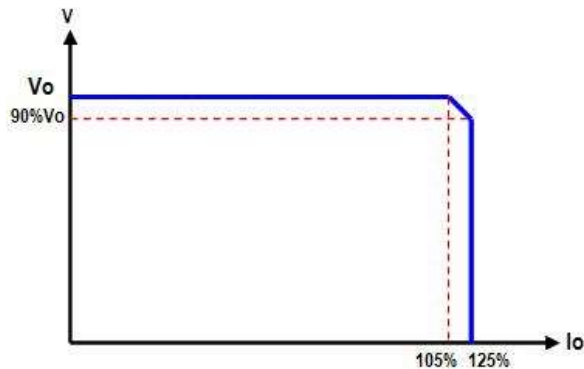

6.3 Output Over Voltage Protection

The converter is protected against output over voltage conditions. When the output voltage is higher than the specified range, the module enters a hiccup mode of operation.

Note: Please note that device inside the power supply might fail when voltage more than rate output voltage is applied to output pin. This could happen when the customer tests the over voltage protection of unit.

6.4 Over Temperature Protection

These modules have an over temperature protection circuit to safeguard against thermal damage. Shutdown occurs with the maximum case reference temperature is exceeded. The module will restart when the case temperature falls below over temperature recovery threshold. Please measured at point A. (Measuring point A refer to the following figure)

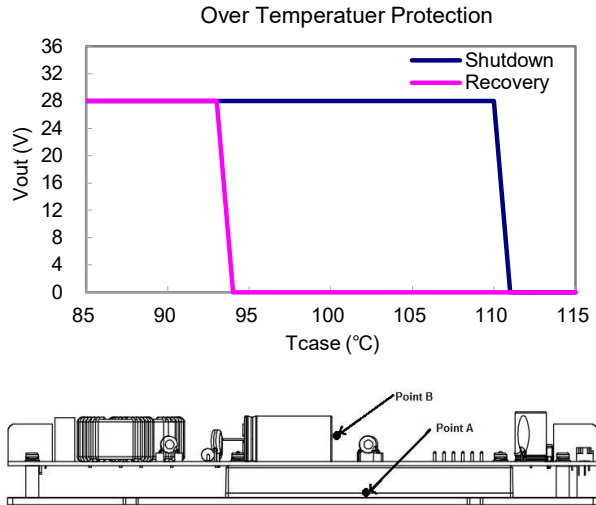

6.5 Remote On/Off

The **on/off** input pins permit the user to turn the power module on or off via a system signal from the primary side or the secondary side. Two remote **on/off** options are available. Negative logic turns the module on as long as a short jumper -on/off and -Vin. Positive logic turns the module off as long as a short jumper -on/off and -Vin.

Logic State (CN1)	Negative Logic	Positive Logic
Logic Low	Module on	Module off
Logic High	Module off	Module on

The converter remote **on/off** circuit built-in on input side. The ground pin of input side remote **on/off** circuit is -Vin pin. Connection examples see below.

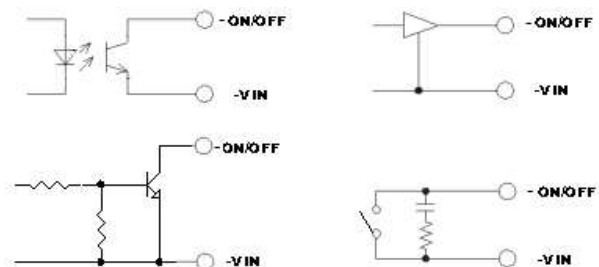

Remote On/Off Connection Example



CFB600W-110S CMFD Series Application Note V12

6.6 Output Remote Sensing

The CFB600W-110SXX-CMFD series converter has the capability to remotely sense both lines of its output. This feature moves the effective output voltage regulation point from the output of the unit to the point of connection of the remote sense pins. This feature automatically adjusts the real output voltage of the CFB600W-110SXX-CMFD series in order to compensate for voltage drops in distribution and maintain a regulated voltage at the point of load. The remote -sense voltage range is:

$$[(+V_{out}) - (-V_{out})] - [(+Sense) - (-Sense)] \leq 10\% \text{ of } V_{o_nominal}$$

When remote sensing is used, please remove the jumper of JP1&JP2. When remote sense is in use, the sense should be connected by twisted-pair wire or shield wire. If the sensing patterns short, heavy current flows and the pattern may be damaged. Output voltage might become unstable because of impedance of wiring and load condition when length of wire is exceeding 400mm. This is shown in the schematic below.

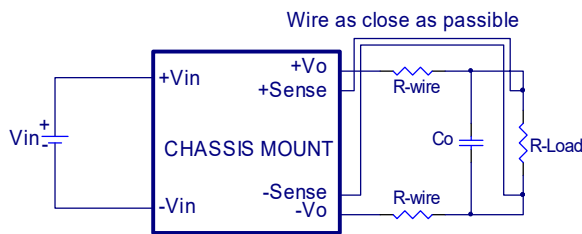

When the CFB600W-110SXX-CMFD module are shipped from a factory, they come with a dedicated jumper being mounted on JP1&JP2. If the remote sense feature is not to be used, the sense pins should be connected locally. The +Sense pin should be connected to the +Vout pin at the module and the -Sense pin should be connected to the -Vout pin at the module. Wire between +Sense and +Vout and between -Sense and -Vout as short as possible. Loop wiring should be avoided. The converter might become unstable by noise coming from poor wiring. This is shown in the schematic below.

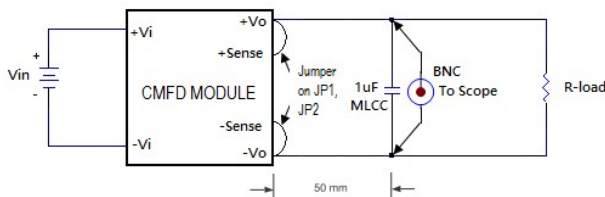

Note:

Although the output voltage can be varied (increased or decreased) by both remote sense and trim, the maximum variation for the output voltage is the larger of the two values not the sum of the values. The output power delivered by the module is defined as the voltage at the output terminals multiplied by the output current. Using remote sense and trim can cause the output voltage to increase and consequently increase the power output of the module if output current remains unchanged. Always ensure that the output power of the module remains at or below the maximum rated power. Also be aware that if V_{o_set} is below nominal value, P_{out_max} will also decrease accordingly because I_{o_max} is an absolute limit. Thus, $P_{out_max} = V_{o_set} \times I_{o_max}$ is also an absolute limit.

6.7 Output Voltage Adjustment

6-7.1 Output Voltage Trim Range(±10%)

Output voltage can be adjusted by internal variable resistor (adjustment range: +10% to -10% of nominal output). Turning internal variable resistor clockwise reduces the output voltage and counterclockwise increases the output voltage.

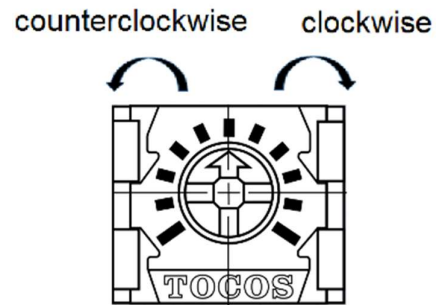

6-7.2 Output Voltage Trim Range(-40%, +10%)

Output may be externally trimmed need to remove jumpers on JP1 and JP2 and CN2 to reach the range of -40%~+10% output voltage. For details, please refer to CFB600W-110SXX series application note.



CFB600W-110S CMFD Series Application Note V12

6.8 IOG Signal

Normal and abnormal operation of the converter can be monitored by using the I.O.G signal. Output of this signal monitor is located at the secondary side and is open collector output, you can use the signal by the internal aux power supply or the external DC supply as the following figures. the ground reference is the -Sense.

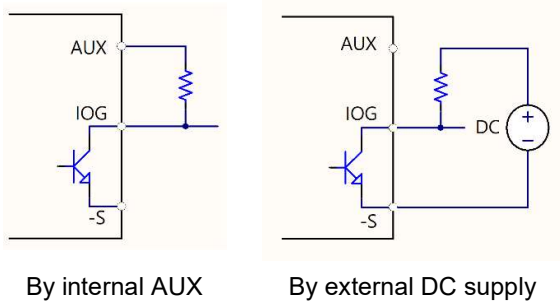

This signal is low when the converter is normally operating and high when the converter is disabled or when the converter is abnormally operating.

6.9 Auxiliary Power for Output Signal

The auxiliary power supply output is within 7-13V with maximum current of 20 mA. Ground reference is the -sense Pin.

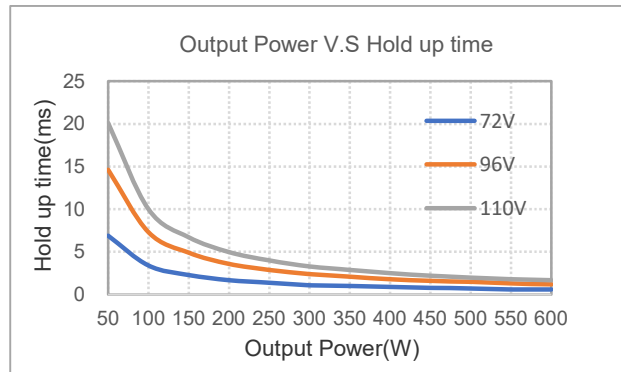

To meet power supply interruptions, an external circuit is required, shown below.

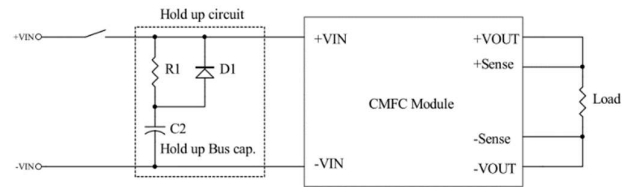

D1:200V/20A
R1:100Ω/10W

C2	72Vin	96Vin	110Vin
Hold up time for 10ms	3900uF	1900uF	1400uF
Hold up time for 30ms	12000uF	5600uF	4000uF

7. Input / Output Considerations

7.1 Hold up Time

Hold up time is defined as the duration of time that DC/DC converter output will remain active following a loss of input power. The test condition and test curve refer to below.

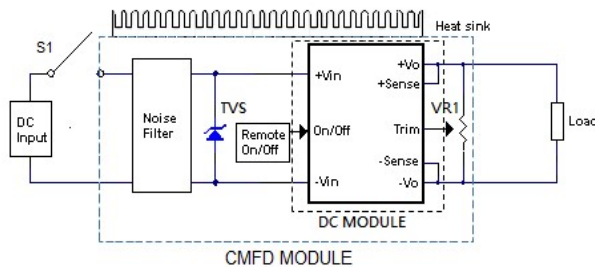



CFB600W-110S CMFD Series Application Note V12

7.2 Output Ripple and Noise

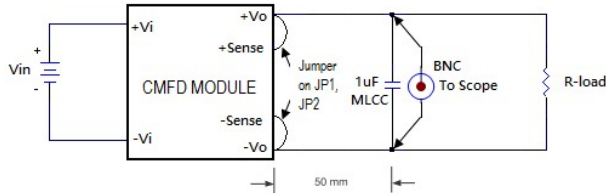

Output ripple and noise measured with 1uF ceramic capacitors across output. A 20 MHz bandwidth oscilloscope is normally used for the measurement.

The conventional ground clip on an oscilloscope probe should never be used in this kind of measurement. This clip, when placed in a field of radiated high frequency energy, acts as an antenna or inductive pickup loop, creating an extraneous voltage that is not part of the output noise of the converter.

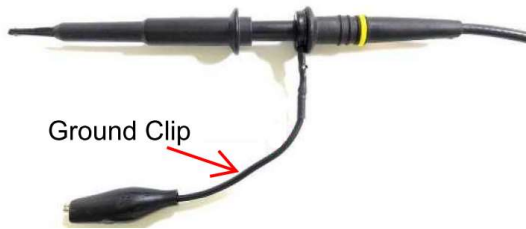

Another method is shown in below, in case of coaxial-cable/BNC is not available. The noise pickup is eliminated by pressing scope probe ground ring directly against the -Vout terminal while the tip contacts the +Vout terminal. This makes the shortest possible connection across the output terminals.

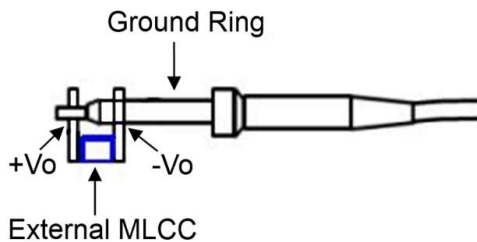

7.3 Output Capacitance

The CFB600W-110SXX-CMFD series converters provide unconditional stability with or without external capacitors. For good transient response, low ESR output capacitors should be located close to the point of load (<100mm). PCB design emphasizes low resistance and inductance tracks in consideration of high current applications. Output capacitors with their associated ESR values have an impact on loop stability and bandwidth. Cincon's converters are designed to work with load capacitance to see technical specifications.

8. Series and Parallel Operation

8.1 Series Operation

Series operation is possible by connecting the outputs two or more units. Connection is shown in below. The output current in series connection should be lower than the lowest rate current in each power module

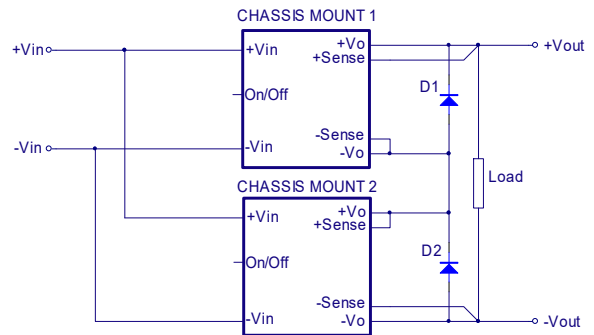

Simple Series Operation Connect Circuit

Note:

Recommend Schottky diode (D1, D2) be connected across the output of each series connected converter, so that if one converter shuts down for any reason, then the output stage won't be thermally overstressed. Without this external diode, the output stage of the shut-down converter could carry the load current provided by the other series converters, with its MOSFETs conducting through the body diodes. The MOSFETs could then be overstressed and fail. The external diode should be capable of handling the full load current for as long as the application is expected to run with any unit shut down.

Series for \pm output operation is possible by connecting the outputs two units, as shown in the schematic below.

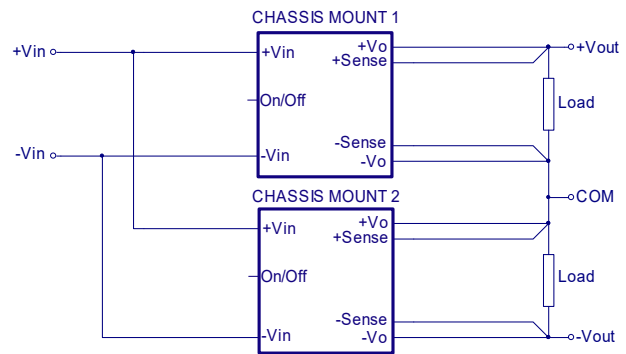

Simple \pm Output Operation Connect Circuit



CFB600W-110S CMFD Series Application Note V12

8.2 Parallel/Redundant Operation

The CFB600W-110SXX-CMFD are also designed for parallel operation. When paralleled, the load current can be equally shared between the modules by connecting the PC pins together.

There are two different parallel operations for CFB600W-110SXX-CMFD, one is parallel operation when load can't be supplied by only one power unit; the other is the N+1 redundant operation which is high reliable for load of N units by using N+1 units.

(a) parallel operation

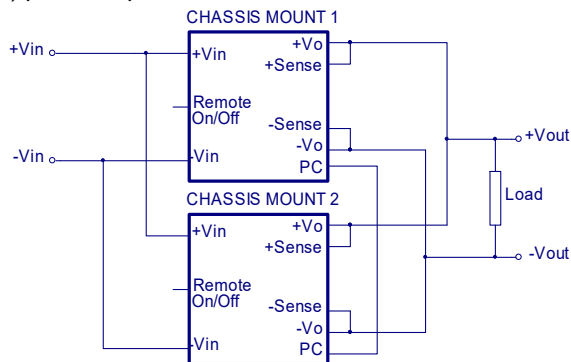

Simple Parallel Operation Connect Circuit

(b) N+1 redundant connection

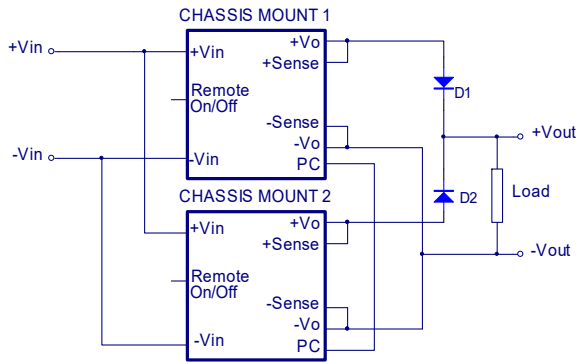

Simple Redundant Operation Connect Circuit



CFB600W-110S CMFD Series

Application Note V12

9. Thermal Design

9.1 Operating Temperature Range

The CFB600W-110SXX-CMFD series converters can be operated within a wide case temperature range of -40°C to 100°C. Consideration must be given to the derating curves when ascertaining maximum power that can be drawn from the converter. The maximum power drawn from chassis mount models is influenced by usual factors, such as:

- Input voltage range
- Output load current
- Forced air or natural convection
- Heat sink optional

9.2 Convection Requirements for Cooling

To predict the approximate cooling needed for the chassis mount module, refer to the power derating curves in **section 9.4**. These derating curves are approximations of the ambient temperatures and airflows required to keep the power module temperature below its maximum rating. Once the module is assembled in the actual system, the module's aluminum plate (point A) and aluminum capacitor (point B) temperature should be monitored to ensure it does not exceed 100°C (measuring point A and measuring point B refer to the **section 6.4**).

9.3 Thermal Considerations

The power module operates in a variety of thermal environments; however, sufficient cooling should be provided to help ensure reliable operation of the unit. Heat is removed by conduction, convection, and radiation to the surrounding environment. The example is presented in **section 9.4**. The power output of the module should not be allowed to exceed rated power ($V_{o_set} \times I_{o_max}$).

9.4 Power Derating

The operating case temperature range of CFB600W-110SXX-CMFD series is -40°C to 100°C. When operating the CFB600W-110SXX-CMFD series, proper derating or cooling is needed. The point A and point B maximum temperature under any operating condition should not exceed 100°C (point A and point B refer to the **section 6.4**). The following curve is the de-rating curve of CFB600W-110SXX-CMFD series with heat sink.



CFB600W-110S CMFD Series Application Note V12

The test condition refers to following figures.

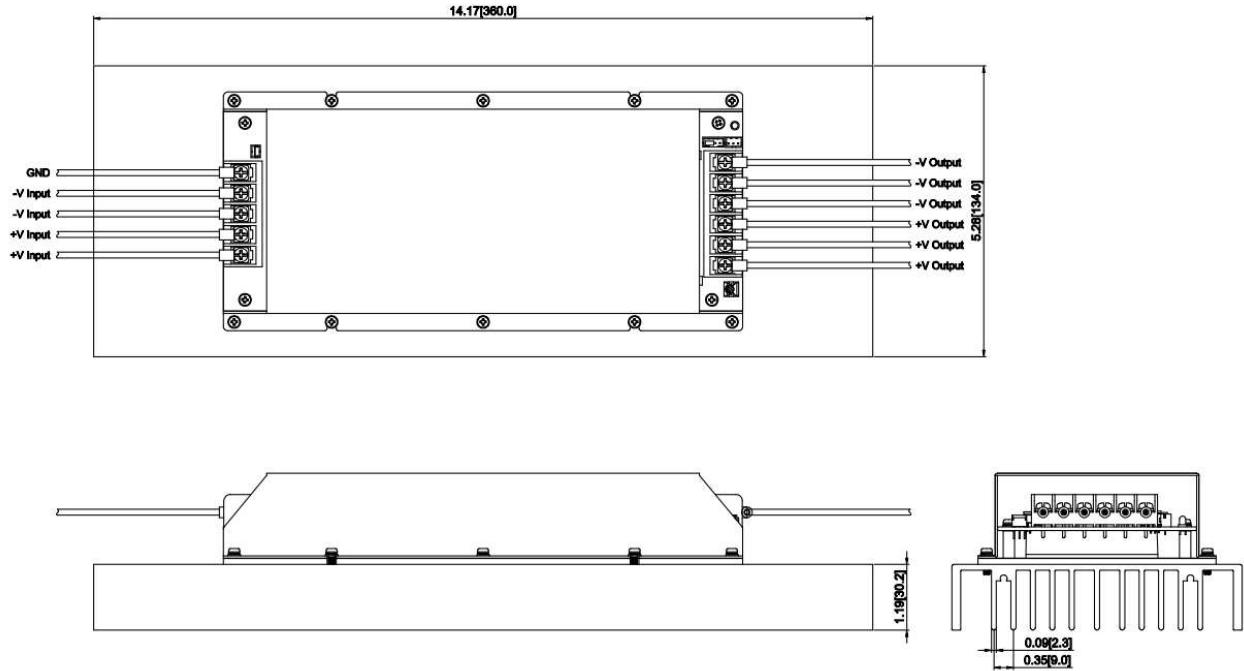

Figures 1 CFB600W-110SXX-CMFD with Heat Sink (14.17x5.28x1.19inch)

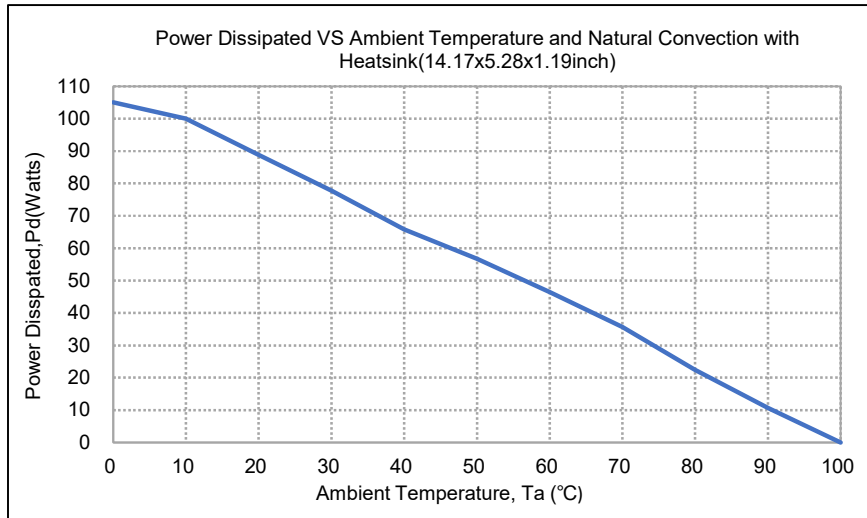

HEATSINK (14.17x5.28x1.19inch)	
AIR FLOW RATE	TYPICAL R_{ca}
Natural Convection 20ft./min. (0.1m/s)	0.9 °C/W



CFB600W-110S CMFD Series Application Note V12

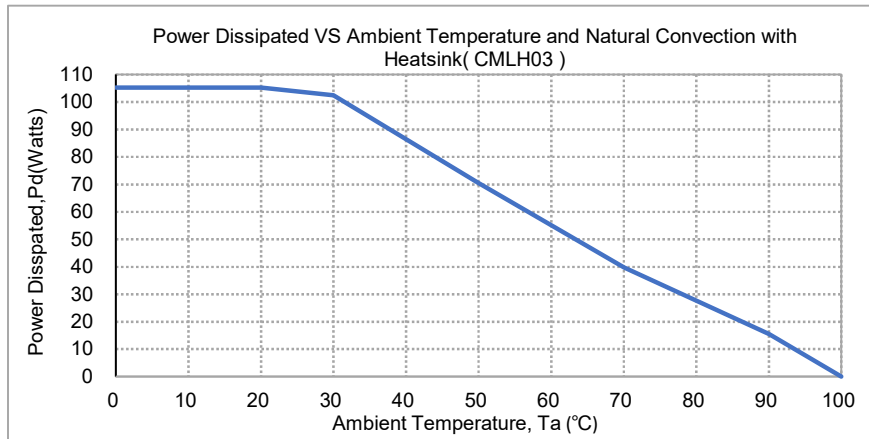
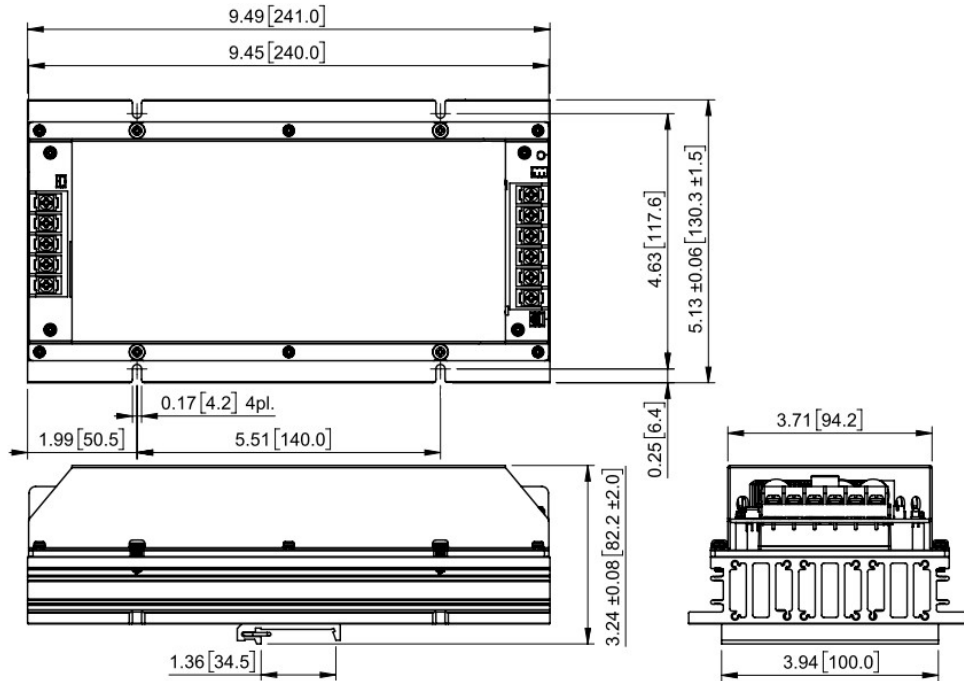

HEATSINK (CMLH03)	
AIR FLOW RATE	TYPICAL R_{ca}
Natural Convection 20ft./min. (0.1m/s)	0.68 °C/W

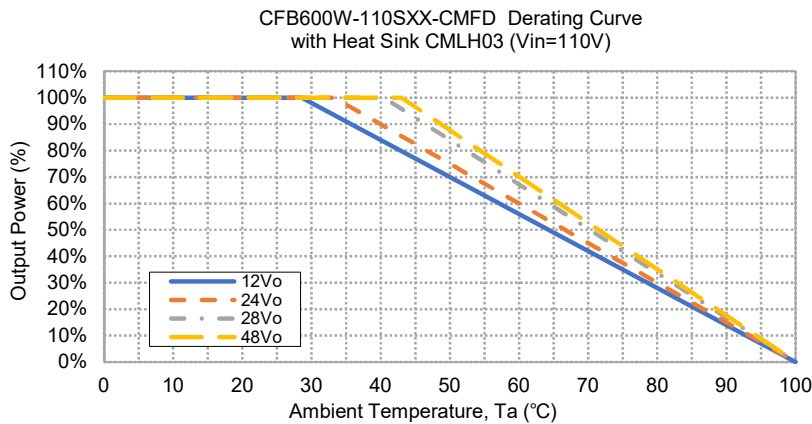



CFB600W-110S CMFD Series Application Note V12

Example (with heat sink):

How to make a CFB600W-110S12-CMFD operating at nominal line voltage, an output current of 34A, and a maximum ambient temperature of 40°C?

Solution:

Given:

$$V_{in}=110Vdc, V_o=12Vdc, I_o=34A$$

Determine Power dissipation (P_d):

$$P_d=P_i-P_o=P_o(1-\eta)/\eta$$

$$P_d=12 \times 34 \times (1-0.86)/0.86=66.4Watts$$

Determine airflow:

$$\text{Given: } P_d=66.4W \text{ and } T_a=40^\circ C$$

Check above Power de-rating curve:

Heat sink with 14.17x5.28x1.19inch

Verify:

$$\text{Maximum temperature rise is } \Delta T=P_d \times R_{ca}=66.4 \times 0.9=59.76^\circ C$$

$$\text{Maximum case temperature is } T_c=T_a+\Delta T=99.76^\circ C < 100^\circ C$$

Where:

The R_{ca} is thermal resistance from case to ambient environment.

T_a is ambient temperature and T_c is case temperature



CFB600W-110S CMFD Series Application Note V12

9.5 Heat Sink

Heat Sink CMLH03

All Dimension In mm

Longitudinal Fins

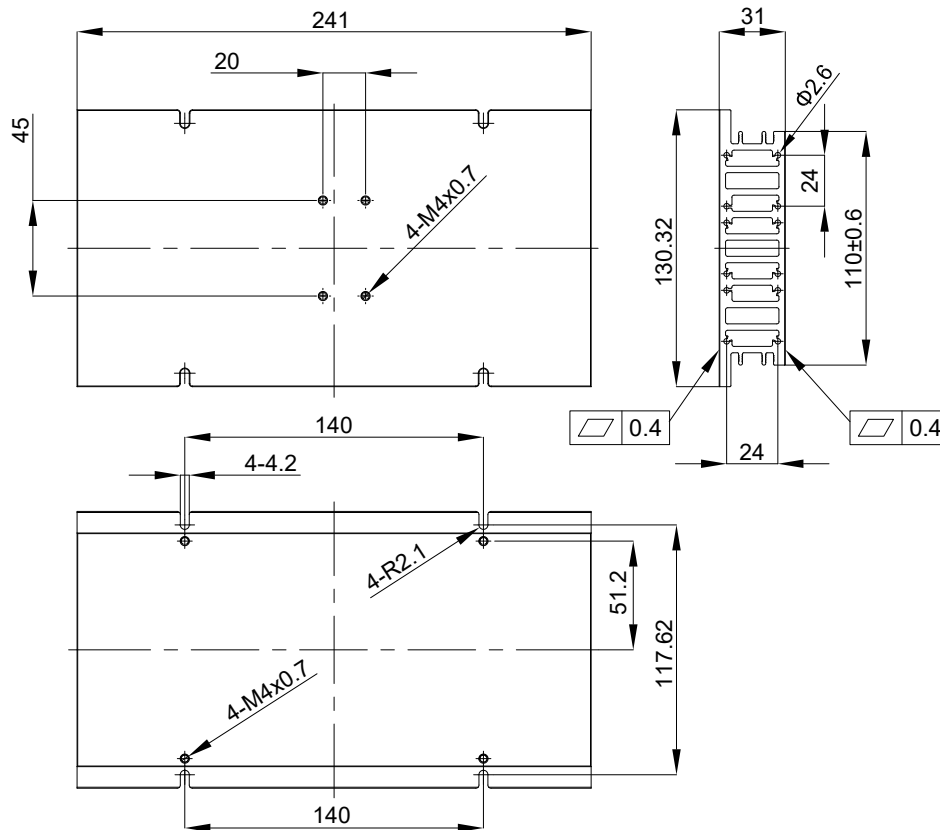

Rca: 0.68 °C/W (typ.), at natural convection

Heat Sink: CMLH03 (M-D354)

Thermal PAD PCM03: PMP-P400 60*115.8*0.23

Screws: SMP4X12N M4*12mm & Spring Washer



CFB600W-110S CMFD Series Application Note V12

10. Safety & EMC

10.1 Input Fusing and Safety Considerations

The CFB600W-110SXX-CMFD series converters have no internal fuse. In order to achieve maximum safety and system protection, always use an input line fuse. We recommended a 20A time delay fuse for all models. CFB600W-110SXX-CMFD module have a transient voltage suppressor diode (TVS) across the input terminal to protect the unit against surge or spike voltage and input reverse voltage (as shown).

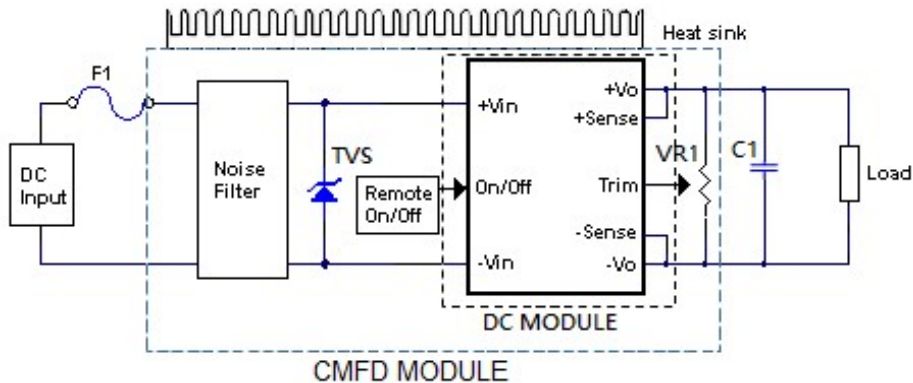

10.2 EMC Considerations

EMI Test standard: EN 50121-3-2 Conducted & Radiated Emission
Test Condition: Input Voltage: 110Vdc, Output Load: Full Load

(1) EMI meet EN 50121-3-2:

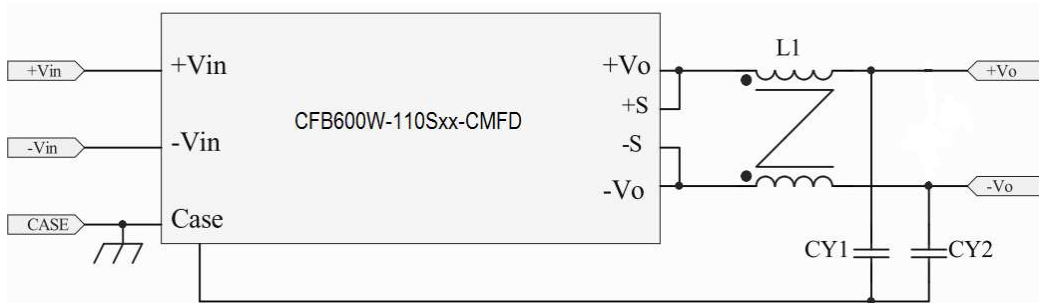

Connection circuit for EMI testing

Model Number				
	110S12-CMFD	110S24-CMFD	110S28-CMFD	110S48-CMFD
CY1	10000pF/Y2	10000pF/Y2	10000pF/Y2	10000pF/Y2
CY2	10000pF/Y2	10000pF/Y2	10000pF/Y2	10000pF/Y2
L1	FERROXCUBE T29/19/15-3E6 1.0mH, Φ 1.0mm*3/9T	FERROXCUBE T29/19/15-3E6 1.0mH, Φ 1.0mm*3/9T	FERROXCUBE T29/19/15-3E6 1.0mH, Φ 1.0mm*3/9T	FERROXCUBE T29/19/15-3E6 2.2mH, Φ 1.2mm*1/14T

Note:

CYxx is MURATA Y2 capacitor or equivalent.



CFB600W-110S CMFD Series Application Note V12

Conducted Emission(Input):

CFB600W-110S12-CMFD

Line

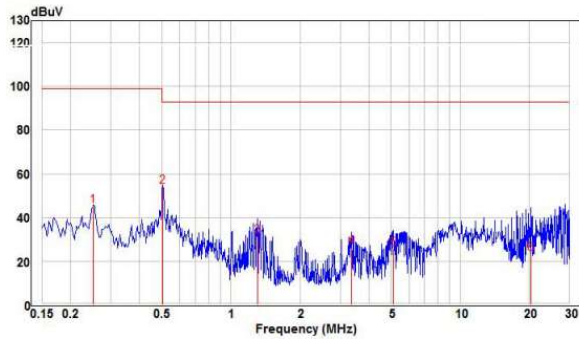

Neutral

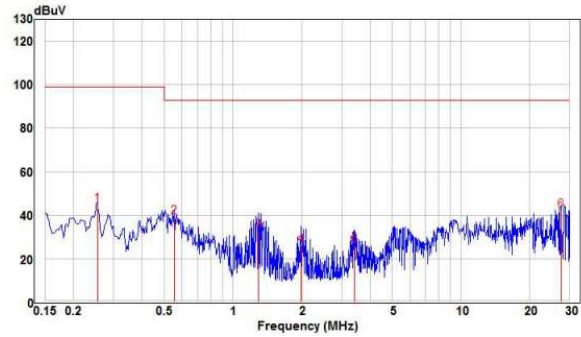

CFB600W-110S24-CMFD

Line

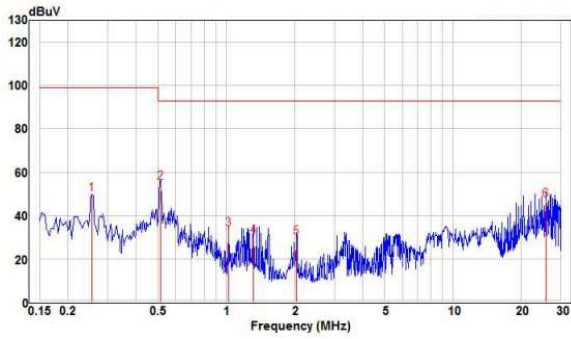

Neutral

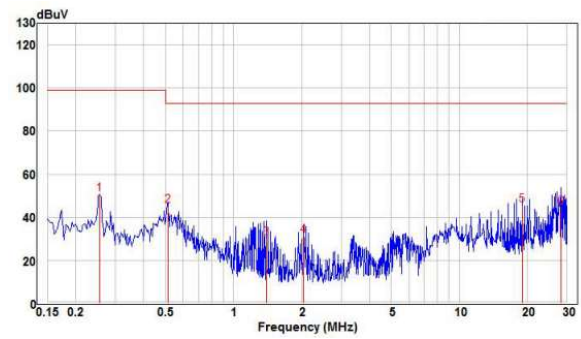

CFB600W-110S28-CMFD

Line

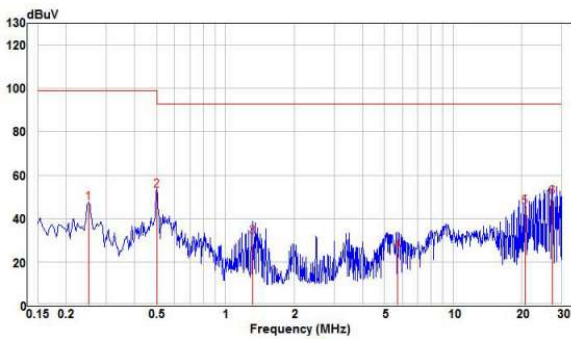

Neutral

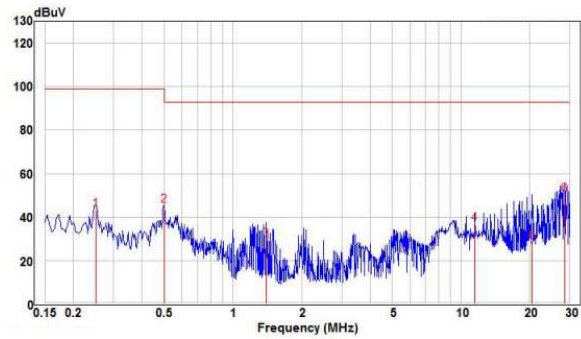



CFB600W-110S CMFD Series Application Note V12

CFB600W-110S48-CMFD

Line

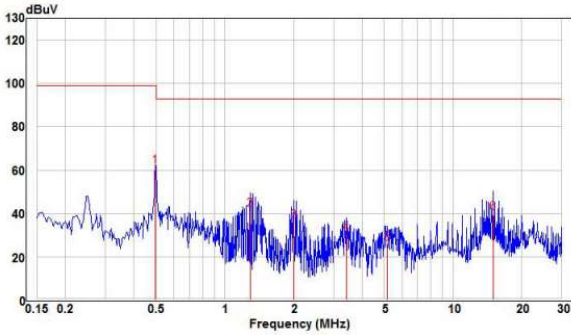

Neutral

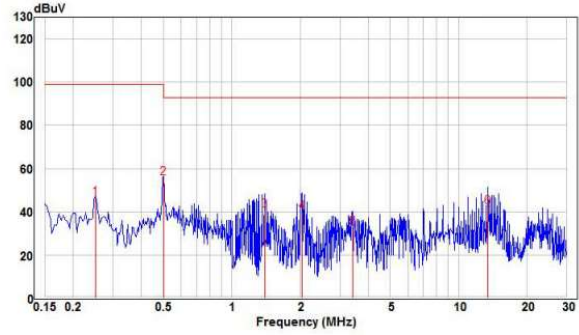

Conducted Emission(Output):

CFB600W-110S12-CMFD

Positive

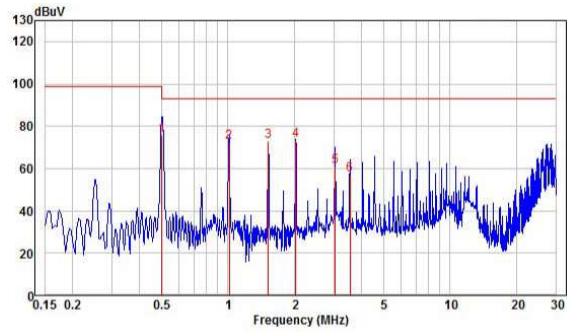

Negative

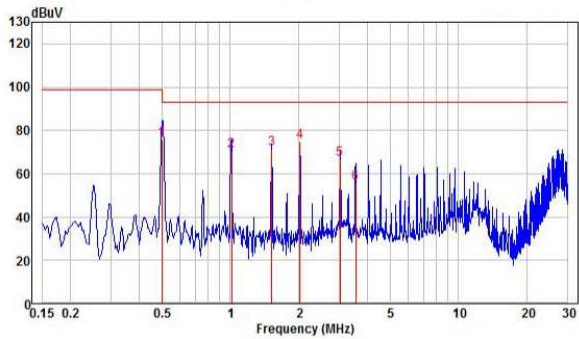

CFB600W-110S24-CMFD

Positive

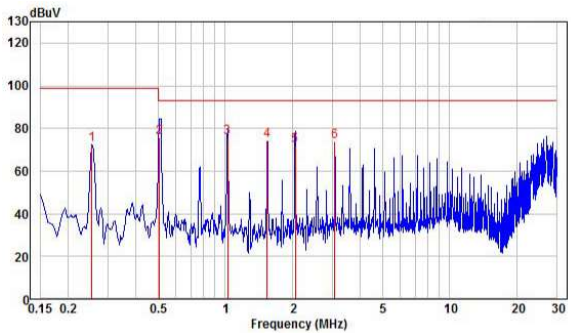

Negative

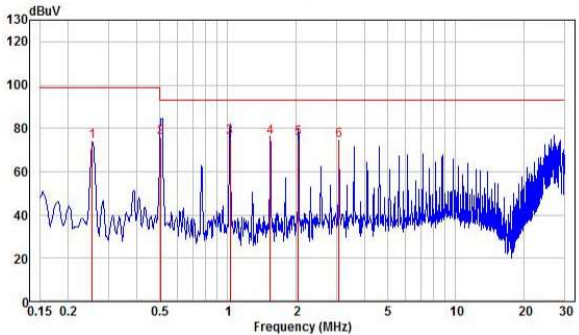



CFB600W-110S CMFD Series Application Note V12

CFB600W-110S28-CMFD

Positive

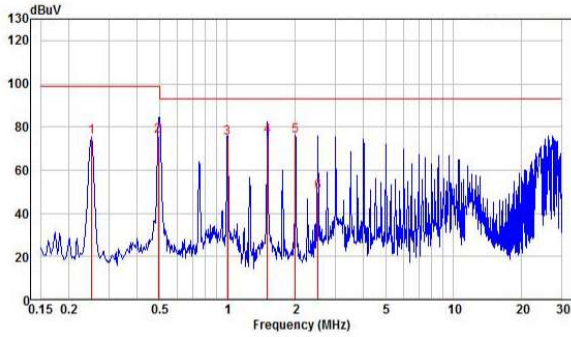

Negative

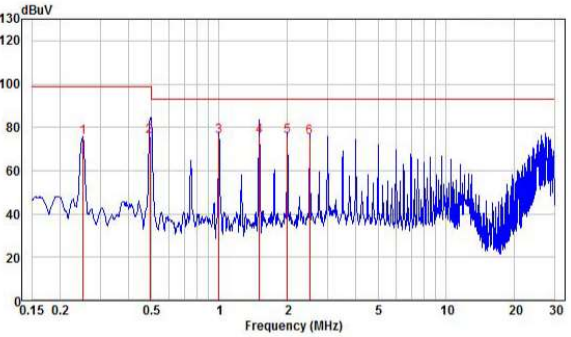

CFB600W-110S48-CMFD

Positive

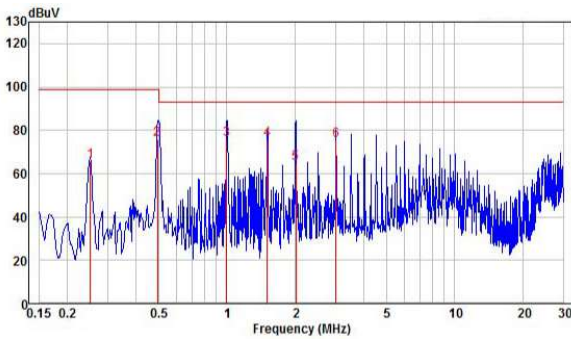

Negative

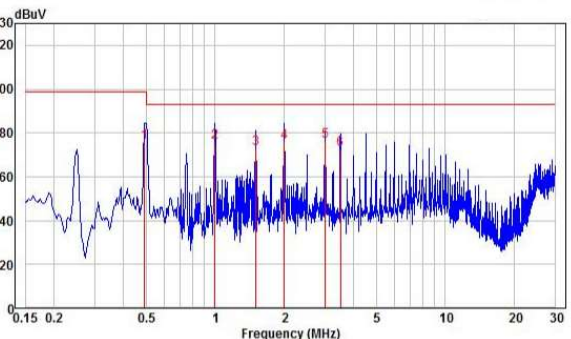

Radiated Emission:

CFB600W-110S12-CMFD

Horizontal

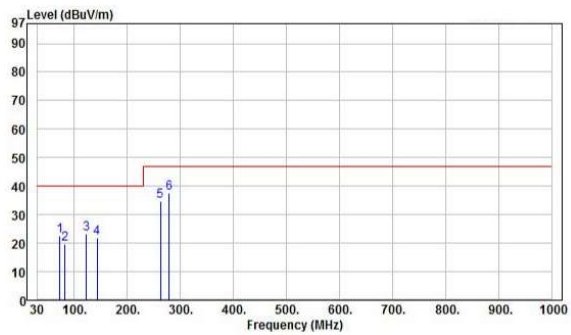

Vertical

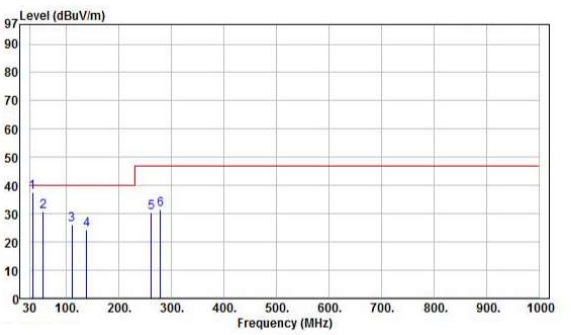



CFB600W-110S CMFD Series Application Note V12

CFB600W-110S24-CMFD

Horizontal

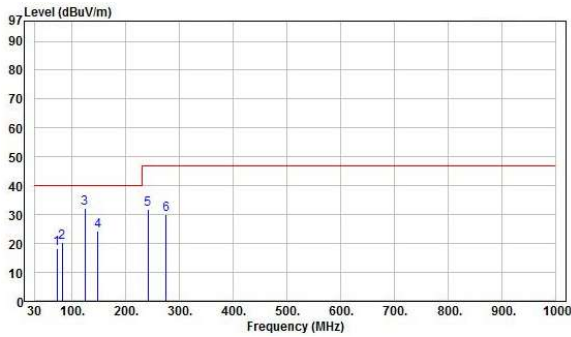

Vertical

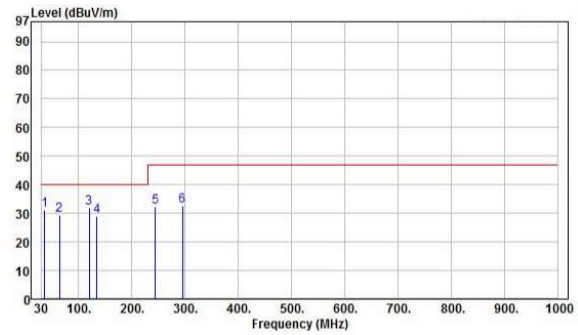

CFB600W-110S28-CMFD

Horizontal

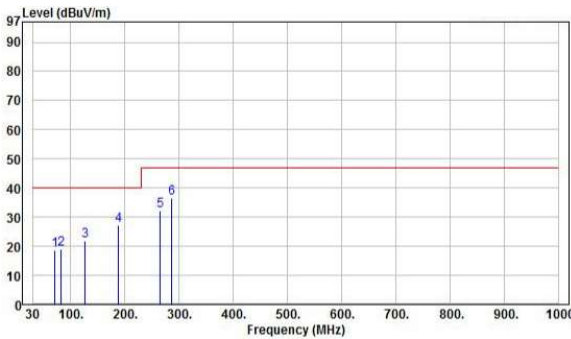

Vertical

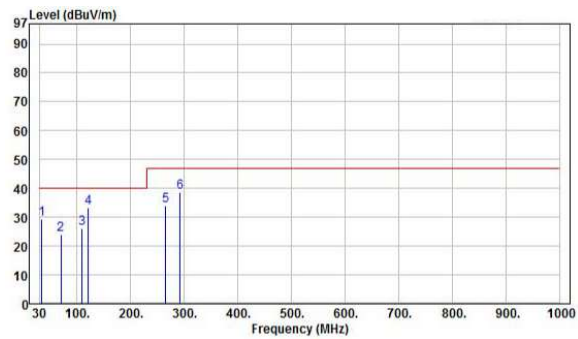

CFB600W-110S48-CMFD

Horizontal

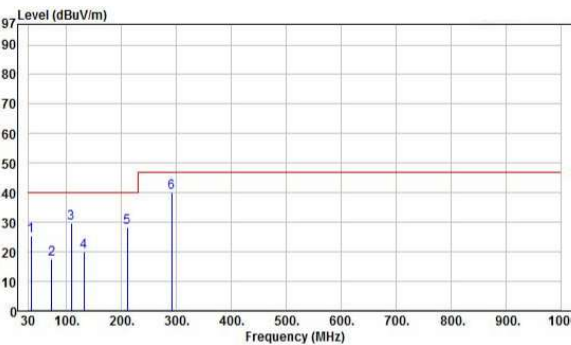

Vertical

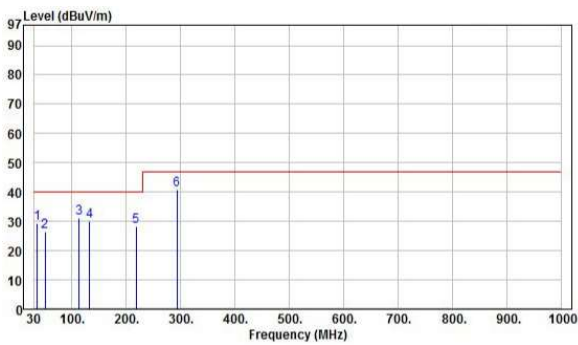

CINCON ELECTRONICS CO., LTD.

Headquarters:

14F, No.306, Sec.4, Hsin Yi Rd.
Taipei, Taiwan
Tel: 886-2-27086210
Fax: 886-2-27029852
E-mail: sales@cincon.com.tw
Web Site: <https://www.cincon.com>

Factory:

No. 8-1, Fu Kung Rd.
Fu Hsing Industrial Park
Fu Hsing Hsiang,
ChangHua Hsien, Taiwan
Tel: 886-4-7690261
Fax: 886-4-7698031

Cincon North America:

1655Mesa Verde Ave. Ste 180
Ventura, CA93003
Tel: 805-639-3350
Fax: 805-639-4101
E-mail: info@cincon.com