



CHB300W Series Application Note V15

ISOLATED DC-DC CONVERTER CHB300W SERIES APPLICATION NOTE



Approved By:

Department	Approved By	Checked By	Written By
Research and Development Department	Jacky	Danny/Eunice	Joyce
Design Quality Department	Benny	JoJo	



CHB300W Series Application Note V15

Contents

1. Introduction	3
2. DC-DC Converter Features.....	3
3. Electrical Block Diagram	3
4. Technical Specifications.....	4
5. Main Features and Functions.....	8
5.1 Operating Temperature Range.....	8
5.2 Output Voltage Adjustment.....	8
5.3 Over Current Protection.....	8
5.4 Output Over Voltage Protection.....	8
5.5 Remote On/Off.....	8
5.6 UVLO (Under Voltage Lock Out)	8
5.7 Over Temperature Protection	8
6. Applications.....	9
6.1 Recommended Layout, PCB Footprint and Soldering Information.....	9
6.2 Convection Requirements for Cooling	9
6.3 Thermal Considerations	9
6.4 Input Capacitance at the Power Module	9
6.5 Power De-Rating.....	10
6.6 Half Brick Heat Sinks.....	11
6.7 Efficiency VS. Load	12
6.8 Test Set-Up.....	14
6.9 Output Voltage Adjustment.....	14
6.10 Output Remote Sensing	16
6.11 Output Ripple and Noise	16
6.12 Output Capacitance.....	16
7. Safety & EMC	17
7.1 Input Fusing and Safety Considerations.....	17
7.2 EMC Considerations	17
8. Part Number.....	19



CHB300W Series Application Note V15

1. Introduction

This specification describes the features and functions of Cincon's CHB300W series of isolated DC-DC converters. These are highly efficient, reliable and compact, high power density, single output DC/DC converters. The modules can be used in the field of telecommunications, data communications, wireless communications, servers etc. The CHB300W series can deliver up to 60A output current and provide a precisely regulated output voltage over a wide range of 9-36VDC and 18-75VDC. The modules can achieve high efficiency up to 92%. The module offers direct cooling of thermal performance. Standard features include remote on/off (positive or negative), remote sense, output voltage adjustment, over voltage, over current and over temperature protection.

2. DC-DC Converter Features

- 300W Isolated Output
- Efficiency to 92%
- Fixed Switching Frequency
- Input Under Voltage Protection
- Over Temperature Protection
- Over Voltage/Current Protection
- Remote On/Off
- Industry Standard Half-Brick Package
- Fully Isolated 1500VDC
- IEC/EN/UL 62368-1 Approval

3. Electrical Block Diagram

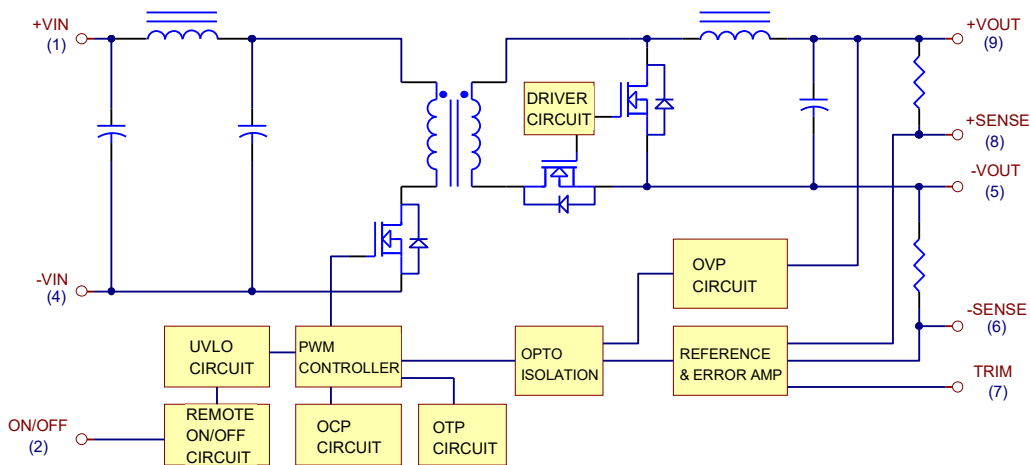

Electrical Block Diagram for 5Vout, 12Vout and 15Vout

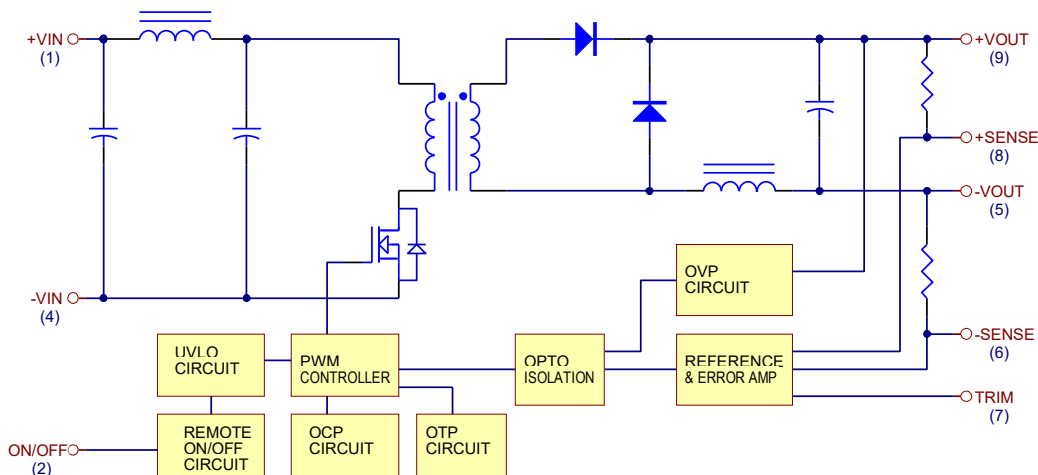

Electrical Block Diagram for other modules



CHB300W Series Application Note V15

4. Technical Specifications

(All specifications are typical at nominal input, full load at 25°C unless otherwise noted.)

ABSOLUTE MAXIMUM RATINGS

Stresses in excess of the absolute maximum ratings can cause permanent damage to the device. These are absolute stress ratings only, functional operation of the device is not implied at these or any other conditions in excess of those given in the operations sections of the data sheet. Exposure to absolute maximum ratings for extended periods can adversely affect the device reliability.

PARAMETER	NOTES and CONDITIONS	Device	Min.	Typical	Max.	Units
Input Voltage						
Continuous		24SXX	-0.3		36	V _{dc}
		48SXX	-0.3		75	
Transient	100ms	24SXX			50	V _{dc}
		48SXX			100	
Operating Case Temperature		All	-40		100	°C
Storage Temperature		All	-55		105	°C
Input/Output Isolation Voltage	1 minute	All	1500			V _{dc}

INPUT CHARACTERISTICS

PARAMETER	NOTES and CONDITIONS	Device	Min.	Typical	Max.	Units
Operating Input Voltage		24SXX	9	24	36	V _{dc}
		48SXX	18	48	75	
Turn-On Voltage Threshold		24SXX	8	8.8	9	V _{dc}
		48SXX	16	17	18	
Turn-Off Voltage Threshold		24SXX	7	8.0	8.5	V _{dc}
		48SXX	15	16	17	
Lockout Hysteresis Voltage		24SXX		0.8		V _{dc}
		48SXX		1		
Maximum Input Current	100% Load, V _{in} =9V	24SXX			40	A
	100% Load, V _{in} =18V	48SXX			19	
No-Load Input Current		24S05		200		mA
		24S12		200		
		24S15		250		
		24S24		80		
		24S28		80		
		24S48		100		
		48S05		100		
		48S12		120		
		48S15		130		
		48S24		60		
		48S28		60		
48S48		80				
Inrush Current (I ² t)		All			1	A ² s
Recommended Input Fuse	Fast blow type	24SXX		45		A
		48SXX		30		
Input Capacitance (External)	<0.7Ω ESR	24SXX	1000			uF
		48SXX	220			



CHB300W Series Application Note V15

OUTPUT CHARACTERISTICS

PARAMETER	NOTES and CONDITIONS	Device	Min.	Typical	Max.	Units	
Output Voltage Set Point	V_{in} =Nominal V_{in} , $I_o = I_{o_max.}$, $T_c=25^\circ C$	$V_o=5.0V$	4.95	5	5.05	V_{dc}	
		$V_o=12V$	11.88	12	12.12		
		$V_o=15V$	14.85	15	15.15		
		$V_o=24V$	23.76	24	24.24		
		$V_o=28V$	27.72	28	28.28		
		$V_o=48V$	47.52	48	48.48		
Output Voltage Regulation							
Load Regulation	$I_o=I_{o_min.}$ to $I_{o_max.}$	All			± 0.2	%	
Line Regulation	V_{in} =low line to high line	All			± 0.2	%	
Temperature Coefficient	$T_c=-40^\circ C$ to $100^\circ C$	All			± 0.03	%/ $^\circ C$	
Output Voltage Ripple and Noise							
Peak-to-Peak	5Hz to 20MHz bandwidth, Full load, 10uF tantalum (for 24S05 with 330uF tantalum, 24S12 with 100uF tantalum and 48Vout with 10uF aluminum) and 1uF ceramic capacitor across output	$V_o=5.0V$			100	mV	
		$V_o=12V$			120		
		$V_o=15V$			200		
		$V_o=24\&28V$			280		
		$V_o=48V$			480		
RMS		$V_o= 5.0V$				40	mV
		$V_o=12V$				60	
		$V_o=15V$				80	
		$V_o=24\&28V$				100	
		$V_o=48V$				200	
Operating Output Current Range		$V_o=5.0V$	0		60	A	
		$V_o=12V$	0		25		
		$V_o=15V$	0		20		
		$V_o=24V$	0		12.5		
		$V_o=28V$	0		10.7		
		$V_o=48V$	0		6.25		
Output Peak Power	3 Seconds with maximum duty cycle of 10%, average output power not to exceed 300W	All			350	Watt	
Output Current Limit Inception	Output voltage=90% nominal output voltage	All	120	125	160	%	
Output Capacitance	Full load (resistive)	24S05	470		10000	uF	
		24S12	330		10000		
		24S15	0		10000		
		24S24	220		4700		
		24S28	220		4700		
		24S48	220		2200		
Output Capacitance	Full load (resistive)	48S05	0		10000	uF	
		48S12	0		10000		
		48S15	0		10000		
		48S24	0		4700		
		48S28	0		4700		
		48S48	220		2200		



CHB300W Series Application Note V15

DYNAMIC CHARACTERISTICS

PARAMETER	NOTES and CONDITIONS	Device	Min.	Typical	Max.	Units
Output Voltage Current Transient						
Step Change in Output Current	$dI/dt=0.1A/us$, Load change from 75% to 100% to 75% of I_o , max.	All			± 5	% V_o
Setting Time (within 1% V_{out} nominal)	$dI/dt=0.1A/us$	All			500	us
Turn-On Delay and Rise Time						
Turn-On Delay Time, From On/Off Control	$V_{on/off}$ to 90% V_{o_set}	All		40	75	ms
Turn-On Delay Time, From Input	$V_{in_min.}$ to 90% V_{o_set}	All		120	250	ms
Output Voltage Rise Time	10% V_{o_set} to 90% V_{o_set}	All		25	50	ms

EFFICIENCY

PARAMETER	NOTES and CONDITIONS	Device	Min.	Typical	Max.	Units	
Efficiency	$V_{in}=1/2$ Nominal V_{in} , 100% Load	24S05		88		%	
		24S12		91			
		24S15		91			
		24S24		88			
		24S28		88.5			
		24S48		88			
		48S05		89			
		48S12		92			
		48S15		92			
		48S24		90			
		48S28		91			
		48S48		90			
	V_{in} =Nominal V_{in} , 100% Load	24S05			88.5		
		24S12			91		
		24S15			91		
		24S24			88		
		24S28			88.5		
		24S48			88		
		48S05			90		
		48S12			92		
		48S15			92		
		48S24			90		
		48S28			89.5		
		48S48			89		

ISOLATION CHARACTERISTICS

PARAMETER	NOTES and CONDITIONS	Device	Min.	Typical	Max.	Units
Isolation Voltage	1 Minute, input to output, input to case, output to case	All			1500	V_{dc}
Isolation Resistance		All	10			$M\Omega$
Isolation Capacitance	Input to Output	All		2000		pF



CHB300W Series Application Note V15

FEATURE CHARACTERISTICS

PARAMETER	NOTES and CONDITIONS	Device	Min.	Typical	Max.	Units
Switching Frequency		All		220		KHz
On/Off Control, Positive Remote On/Off Logic						
Logic Low (Module Off)		All	0		1.2	V
Logic High (Module On)		All	3.5 or Open Circuit		75	V
On/Off Control, Negative Remote On/Off Logic						
Logic High (Module Off)		All	3.5 or Open Circuit		75	V
Logic High (Module On)		All	0		1.2	V
On/Off Current (for Both Remote On/Off Logic)	$I_{on/off}$ at $V_{on/off}=0.0V$	All			1	mA
Leakage Current (for Both Remote On/Off Logic)	Logic high, $V_{on/off}=15V$	All			1	mA
Off Converter Input Current	Shutdown input idle current	All		7	10	mA
Output Voltage Trim Range	$V_{in}=18-23V$ $I_{out}=\text{max. rated current}$	48S28	-10		0	%
	$V_{in}=23-75V$, $P_{out}=\text{max. rated power}$ $I_{out}=\text{max. rated current}$	48S28	-10		+10	
	$P_{out}=\text{max. rated power}$	Others	-10		+10	
Output Over Voltage Protection		All	115	125	140	%
Over-Temperature Shutdown		All		110		°C

GENERAL SPECIFICATIONS

PARAMETER	NOTES and CONDITIONS	Device	Min.	Typical	Max.	Units
MTBF	$I_o=100\%$ of $I_{o,max}$: $T_a=25^\circ C$ per MIL-HDBK-217F	All		600		K hours
Weight		All		114		grams



CHB300W Series Application Note V15

5. Main Features and Functions

5.1 Operating Temperature Range

The CHB300W series converters can be operated within a wide case temperature range of -40°C to 100°C . Consideration must be given to the de-rating curves when ascertaining maximum power that can be drawn from the converter. The maximum power drawn from half brick models is influenced by usual factors, such as:

- Input voltage range
- Output load current
- Forced air or natural convection

5.2 Output Voltage Adjustment

Section 6.8 describes in detail how to trim the output voltage with respect to its set point. The output voltage on 5V&12V&15V&24V&28V&48V models is adjustable within the range of +10% to -10%. For 48S28 models, see input& output trim curves.

5.3 Over Current Protection

The converter is protected against over current or short circuit conditions. At the instance of current-limit inception, the module enters a hiccup mode of operation, whereby it shuts down and automatically attempts to restart. While the fault condition exists, the module will remain in this hiccup mode, and can remain in this mode until the fault is cleared. The unit operates normally once the output current is reduced back into its specified range.

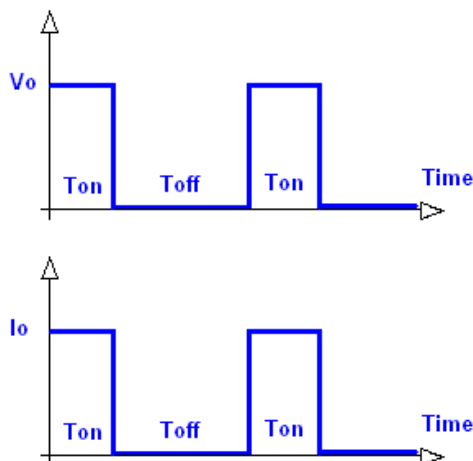

5.4 Output Over Voltage Protection

The converter is protected against output over voltage conditions. When the output voltage is higher than the specified range, the module enters a hiccup mode of operation. The operation is identical with over current protection.

5.5 Remote On/Off

The **on/off** input pin permits the user to turn the power module on or off via a system signal. Two remote **on/off** options are available. Positive logic turns the module on during a logic high voltage on the **on/off** pin, and off during a logic low. Negative logic remote **on/off** turns the module off during a logic high and on during a logic low. The **on/off** pin is internally pulled up through a resistor. A properly de-bounced mechanical switch, open collector transistor, or FET can be used to drive the input of the **on/off** pin.

If not using the remote **on/off** feature:

For positive logic, leave the **on/off** pin open.

For negative logic, short the **on/off** pin to $v_{in}(-)$.

5.6 UVLO (Under Voltage Lock Out)

Input under voltage lockout is standard with this converter. At input voltages below the input under voltage lockout limit, the module operation is disabled.

5.7 Over Temperature Protection

These modules have an over temperature protection circuit to safeguard against thermal damage. When the case temperature rises above over temperature shutdown threshold, the converter will shut down to protect it from overheating. The module will automatically restart after it cools down.



CHB300W Series Application Note V15

6. Applications

6.1 Recommended Layout, PCB Footprint and Soldering Information

The system designer or end user must ensure that metal and other components in the vicinity of the converter meet the spacing requirements for which the system is approved. Low resistance and inductance PCB layout traces are the norm and should be used where possible. Due consideration must also be given to proper low impedance tracks between power module, input and output grounds. The recommended soldering profile and PCB layout are shown below.

Lead Free Wave Soldering Profile

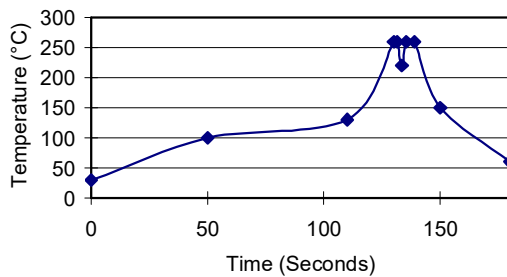

Note :

1. Soldering Materials: Sn/Cu/Ni
2. Ramp up rate during preheat: 1.4°C/Sec (from 50°C to 100°C)
3. Soaking temperature: 0.5°C/Sec (from 100°C to 130°C), 60±20 seconds
4. Peak temperature: 260°C, above 250°C 3~6 Seconds
5. Ramp up rate during cooling: -10.0°C/Sec (from 260°C to 150°C)

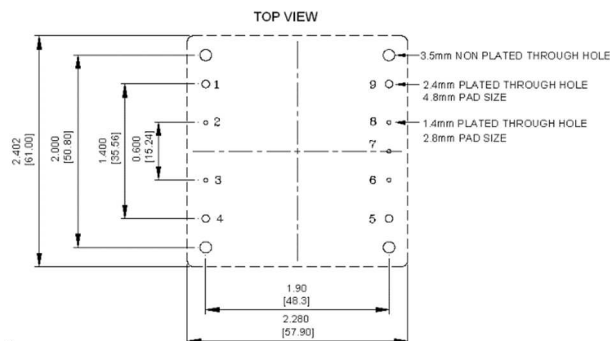

6.2 Convection Requirements for Cooling

To predict the approximate cooling needed for the half brick module, refer to the power de-rating curves in **section 6.5**. These de-rating curves are approximations of the ambient temperatures and airflows required to keep the power module temperature below its maximum rating. Once the module is assembled in the actual system, the module's temperature should be monitored to ensure it does not exceed 100°C as being measured at the center of the top of the case (thus verifying proper cooling).

6.3 Thermal Considerations

The power module operates in a variety of thermal environments; however, sufficient cooling should be provided to help ensure reliable operation of the unit. Heat is removed by conduction, convection, and radiation to the surrounding environment. The test data is presented in **section 6.5**. The power output of the module should not be allowed to exceed rated power ($V_{o_set} \times I_{o_max}$).

6.4 Input Capacitance at the Power Module

The converters must be connected to low AC source impedance. To avoid problems with loop stability source inductance should be low. Also, the input capacitors (C_{in}) should be placed close to the converter input pins to de-couple distribution inductance. However, the external input capacitors are chosen for suitable ripple handling capability. Low ESR capacitors are good choice. Circuit as shown as below represents typical measurement methods for reflected ripple current. C_1 and L_1 simulate a typical DC source impedance. The input reflected-ripple current is measured by current probe to oscilloscope with a simulated source Inductance (L_1).

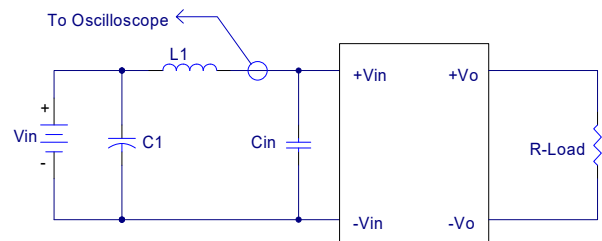

L1: 12uH

C1: NC

C_{in} : 1000uF for 24Vin, 220uF for 48Vin models

ESR<0.7ohm @100KHz

Input Reflected-Ripple Test Setup



CHB300W Series Application Note V15

6.5 Power De-Rating

The operating case temperature range of CHB300W series is -40°C to +100°C. When operating the CHB300W series, proper de-rating or cooling is needed. The maximum case temperature under any operating condition should not exceed 100°C.

The following curve is the de-rating curve of CHB300W series without heat sink.

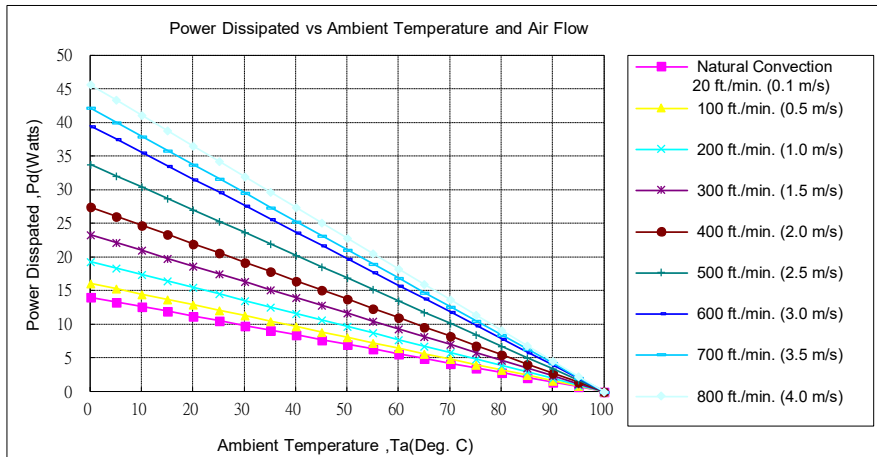

AIR FLOW RATE	TYPICAL R _{ca}
Natural Convection 20ft./min. (0.1m/s)	7.12°C/W
100 ft./min. (0.5m/s)	6.21°C/W
200 ft./min. (1.0m/s)	5.17°C/W
300 ft./min. (1.5m/s)	4.29°C/W
400 ft./min. (2.0m/s)	3.64°C/W
500 ft./min. (2.5m/s)	2.96°C/W
600 ft./min. (3.0m/s)	2.53°C/W
700 ft./min. (3.5m/s)	2.37°C/W
800 ft./min. (4.0m/s)	2.19°C/W

Example (without heatsink):

What is the minimum airflow necessary for a CHB300W-48S05 operating at nominal line voltage, an output current of 60A, and a maximum ambient temperature of 20°C?

Solution:

Given:

$$V_{in}=48Vdc, V_o=5Vdc, I_o=60A$$

Determine power dissipation (Pd):

$$P_d=P_i-P_o=P_o(1-\eta)/\eta$$

$$P_d=5V \times 60A \times (1-0.90)/0.90=33.4Watts$$

Determine airflow:

$$\text{Given: } P_d=33.4W \text{ and } T_a=20^\circ C$$

Check Power de-rating curve:

Minimum airflow=800 ft./min.

Verify:

Maximum temperature rise is

$$\Delta T=P_d \times R_{ca}=33.4W \times 2.19=73.1^\circ C$$

Maximum case temperature is

$$T_c=T_a+\Delta T=93.1^\circ C < 100^\circ C$$

Where:

The R_{ca} is thermal resistance from case to ambient environment

T_a is ambient temperature and T_c is case temperature



CHB300W Series Application Note V15

Example with heatsink HBL210 (M-C308):

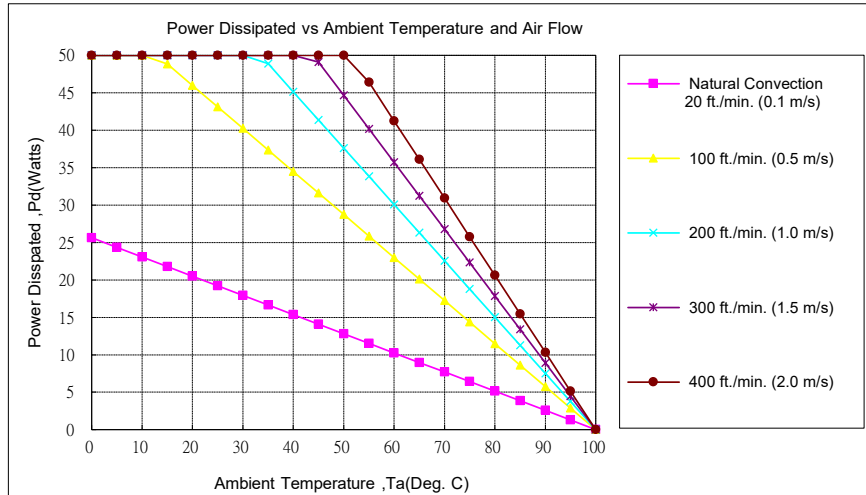

AIR FLOW RATE	TYPICAL R _{ca}
Natural Convection 20ft./min. (0.1m/s)	3.9°C/W
100 ft./min. (0.5m/s)	1.74°C/W
200 ft./min. (1.0m/s)	1.33°C/W
300 ft./min. (1.5m/s)	1.12°C/W
400 ft./min. (2.0m/s)	0.97°C/W

What is the minimum airflow necessary for a CHB300W-48S05 operating at nominal line voltage, an output current of 60A, and a maximum ambient temperature of 40°C?

Solution:

Given:

$$V_{in}=48Vdc, V_o=5Vdc, I_o=60A$$

Determine power dissipation (Pd):

$$P_d=P_i-P_o=P_o(1-\eta)/\eta$$

$$P_d=5V \times 60A \times (1-0.90)/0.90=33.4Watts$$

Determine airflow:

$$\text{Given: } P_d=33.4W \text{ and } T_a=40^\circ C$$

Check power de-rating curve:

$$\text{Minimum airflow}=100 \text{ ft./min.}$$

Verify:

Maximum temperature rise is

$$\Delta T=P_d \times R_{ca}=33.4W \times 1.74=58.1^\circ C$$

Maximum case temperature is

$$T_c=T_a+\Delta T=98.1^\circ C < 100^\circ C$$

Where:

The R_{ca} is thermal resistance from case to ambient environment

T_a is ambient temperature and T_c is case temperature

6.6 Half Brick Heat Sinks

Heat sinks assembly [refer to Datasheet-Thermal](#)



CHB300W Series Application Note V15

6.7 Efficiency VS. Load

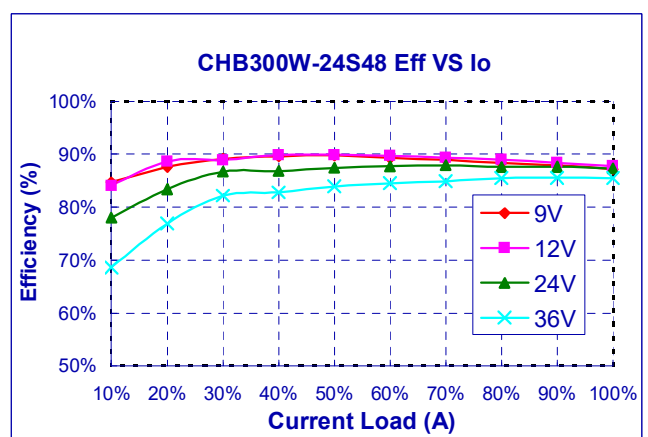
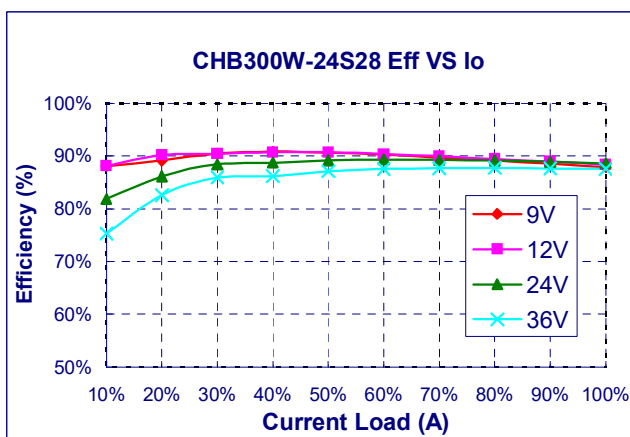
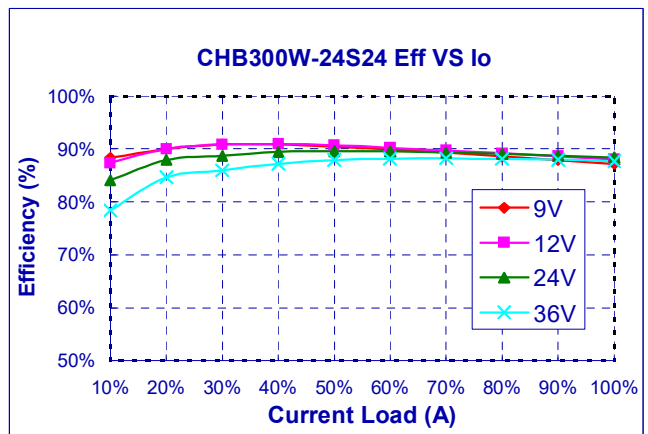
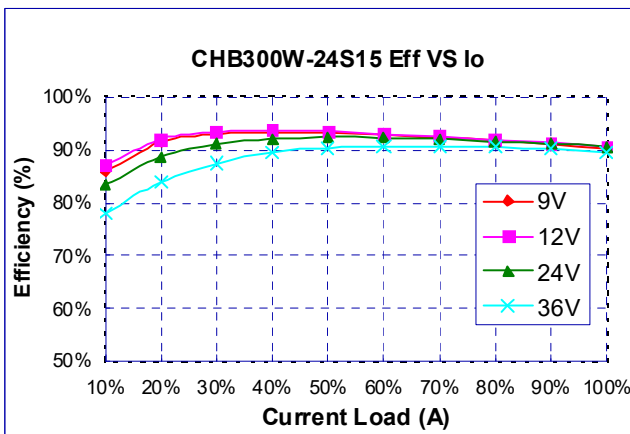
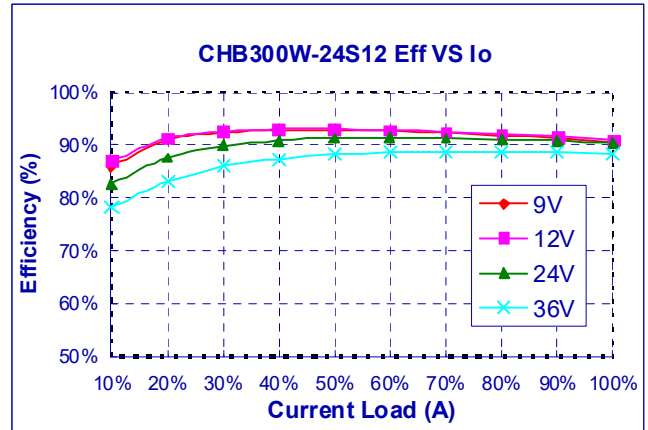
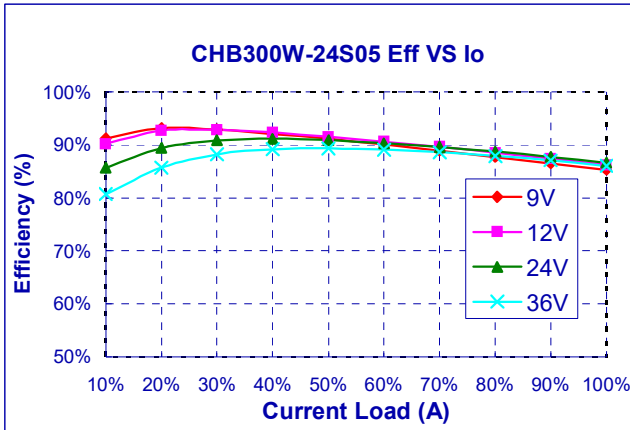



CHB300W Series Application Note V15

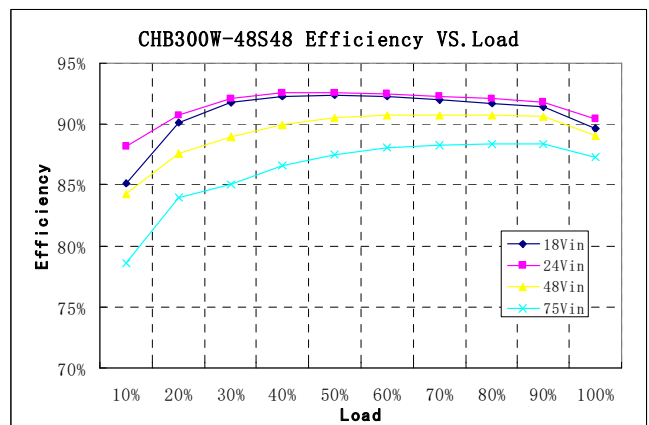
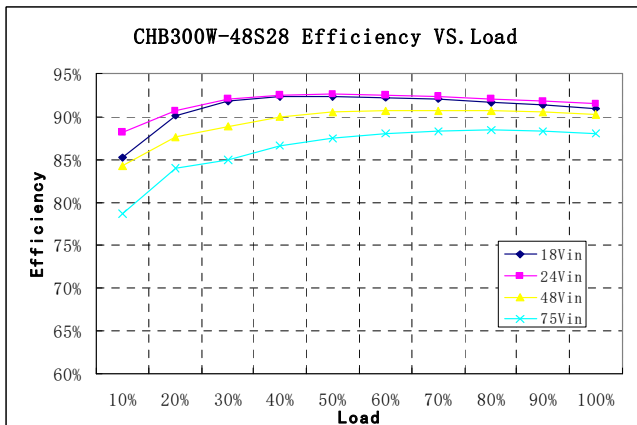
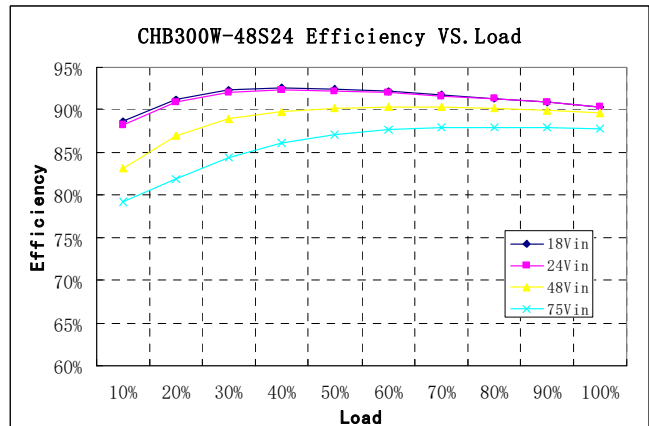
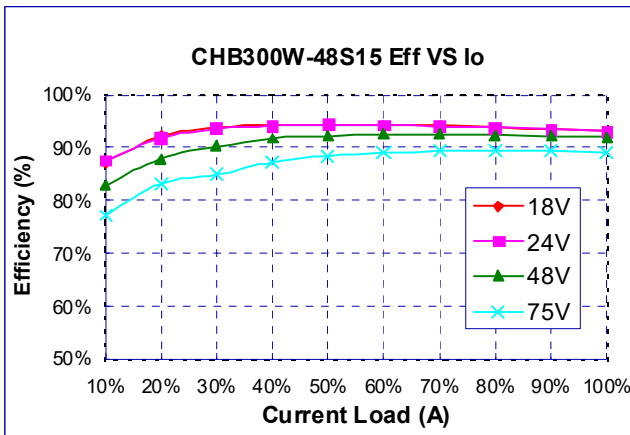
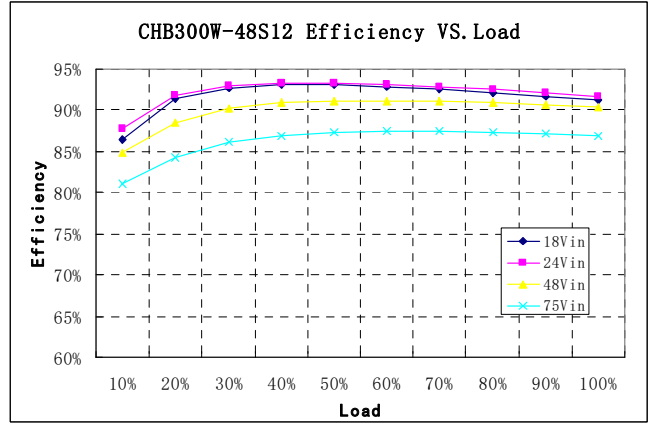
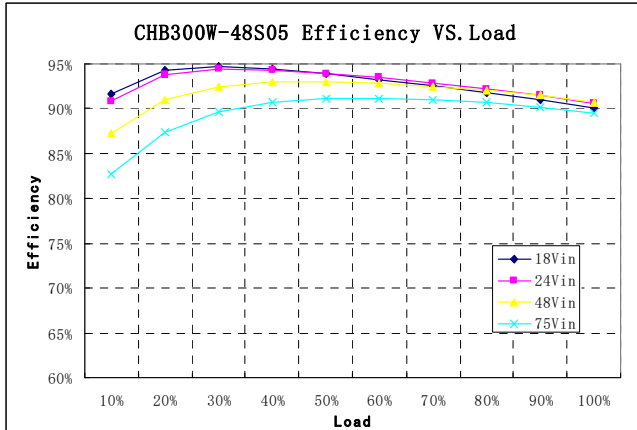



CHB300W Series Application Note V15

6.8 Test Set-Up

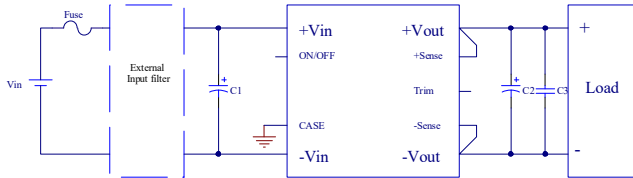

Typical Electrical Connection (Positive Logic)

For typical electrical connection, please refer to the connection above.

1. Put input capacitor C1, more than 1000uF for 24Vin, 220uF for 48Vin, If the ambient temperature is less than -20 °C , use 3 pieces of the recommended capacitor above. If the impedance of input line is high, input capacitor must be more than above.
2. Put output capacitor, C2 and C3 according to minimum and maximum capacitor recommendation on page 5. If the ambient temperature is less than -20°C, use at least 3 pieces of the recommended minimum capacitors.
3. Use external fuse for each unit. The basic test set-up to measure parameters such as efficiency and load regulation is shown below. When testing the modules under any transient conditions please ensure that the transient response of the source is sufficient to power the equipment under test. We can calculate:

- Efficiency
- Load regulation and line regulation

The value of efficiency is defined as:

$$\eta = \frac{V_o \times I_o}{V_{in} \times I_{in}} \times 100\%$$

Where:

- V_o is output voltage,
- I_o is output current,
- V_{in} is input voltage,
- I_{in} is input current

The value of load regulation is defined as:

$$Load.reg = \frac{V_{FL} - V_{NL}}{V_{NL}} \times 100\%$$

Where:

- V_{FL} is the output voltage at full load
- V_{NL} is the output voltage at no load

The value of line regulation is defined as:

$$LINE.reg = \frac{V_{HL} - V_{LL}}{V_{LL}} \times 100\%$$

Where:

V_{HL} is the output voltage of maximum input voltage at full load.

V_{LL} is the output voltage of minimum input voltage at full load.

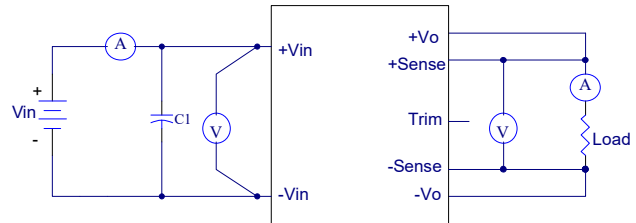

CHB300W Series Test Setup

6.9 Output Voltage Adjustment

The Trim input permits the user to adjust the output voltage up or down 10%. This is accomplished by connecting an external resistor between the Trim pin and either the $V_{out} (+)$ pin or the $V_{out} (-)$ pin (COM pin), see Figure

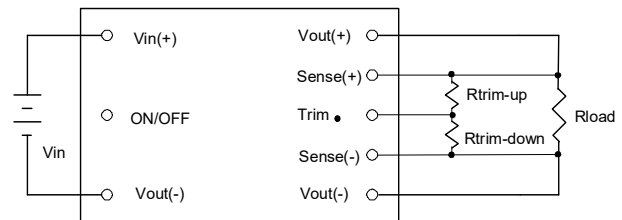

Output Voltage Trim Circuit Configuration

The Trim pin should be left open if trimming is not being used. Connecting an external resistor ($R_{trim-down}$) between the Trim pin and the $V_{out} (-)$ (or Sense (-)) pin decreases the output voltage. The following equation determines the required external resistor value to obtain a down percentage output voltage change of $\Delta\%$

$$R_{trim-down} = \left[\frac{511}{\Delta\%} - 10.22 \right] k\Omega$$

Where

$$\Delta\% = \left(\frac{V_{o,set} - V_{desired}}{V_{o,set}} \right) \times 100$$

For example, to trim-down the output voltage of 12V module (CHB300W-48S12) by 5% to 11.4V, $R_{trim-down}$ is calculated as follow:

$\Delta\%=5$

$$R_{trim-down} = \left(\frac{511}{5} - 10.22 \right) k\Omega$$

$$R_{trim-down} = 91.98k\Omega$$



CHB300W Series Application Note V15

Connecting an external resistor ($R_{trim-up}$) between the Trim pin and the V_{out} (+) (or Sense (+)) pin increases the output voltage. The following equations determine the required external resistor value to obtain a up percentage output voltage change of $\Delta\%$.

$$R_{trim-up} = \left[\frac{5.11V_{out}(100 + \Delta\%)}{1.24 \times \Delta\%} - \frac{511}{\Delta\%} - 10.22 \right] k\Omega$$

Where

$$\Delta\% = \left(\frac{V_{o,set} - V_{desired}}{V_{o,set}} \right) \times 100$$

For example, to trim-up the output voltage of 12V module (CHB300W-48S12) by 5% to 12.6V, $R_{trim-up}$ is calculated as follow:

$\Delta\% = 5$

$$R_{trim-up} = \left(\frac{5.11 \times 12 \times (100 + 5)}{1.24 \times 5} - \frac{511}{5} - 10.22 \right) k\Omega$$

$$R_{trim-up} = 926k\Omega$$

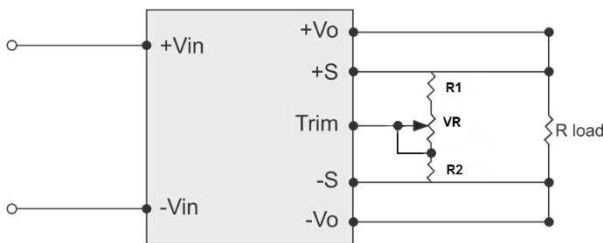

Output Voltage Trim Circuit Configuration with VR

Recommend Resistor Values:

V_{out} (V)	R1 (K Ω)	R2 (K Ω)	VR (K Ω)
5	13	5.6	10
12	33	4.7	20
15	36	3.9	20
24	47.5	3	20
28	51	2.7	20
48	56	1.65	20

$$R1 + VR \geq \frac{37.089 \times R2 \times V_o - 40.88 \times R2}{40.88 - R2} (K\Omega) \dots \dots \dots (1)$$

$$R1 \leq \frac{45.331 \times R2 \times V_o - 61.32 \times R2}{61.32 + R2} (K\Omega) \dots \dots \dots (2)$$

Ex: CHB300W-48S24

IF $R2 = 3K\Omega$

$$R1 + VR \geq \frac{37.089 \times 3 \times 24 - 40.88 \times 3}{40.88 - 3} = 67.259K\Omega$$

$$R1 \leq \frac{45.331 \times 3 \times 24 - 61.32 \times 3}{61.32 + 3} = 47.884K\Omega$$

$$VR \geq 67.259 - 47.884 = 19.375K\Omega$$

R1 use 47.5K, VR use 20K

Note: Although the output voltage can be increased by both the remote sense and by the trim, the maximum increase for the output voltage is not the sum of both. The maximum increase is the larger of either the remote sense or the trim. The amount of power delivered by the module is defined as the voltage at the output terminals multiplied by the output current. When using remote sense and trim, the output voltage of the module can be increased and consequently increase the power output of the module if output current remains unchanged. Care should be taken to ensure that the maximum output power of the module remains at or below the maximum rated power (Maximum rated power = $V_{o,set} \times I_{o,max}$.)

The output voltage on 5V&12V&15V& 24V&28V&48V model is adjustable within the range of +10% to -10%. For 48S28 model see input & output trim curves for trim up and trim down is -10%.

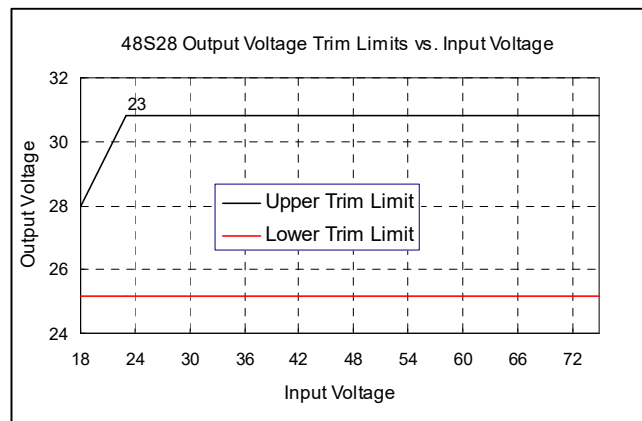



CHB300W Series Application Note V15

6.10 Output Remote Sensing

The CHB300W Series converter has the capability to remotely sense both lines of its output. This feature moves the effective output voltage regulation point from the output of the unit to the point of connection of the remote sense pins. This feature automatically adjusts the real output voltage of the CHB300W series in order to compensate for voltage drops in distribution and maintain a regulated voltage at the point of load. The remote-sense voltage range is:

$$[(+V_{out}) - (-V_{out})] - [(+Sense) - (-Sense)] \leq 10\% \text{ of } V_{o_nominal}$$

If the remote sense feature is not to be used, the sense pins should be connected locally. The +Sense pin should be connected to the +Vout pin at the module and the -Sense pin should be connected to the -Vout pin at the module.

6.11 Output Ripple and Noise

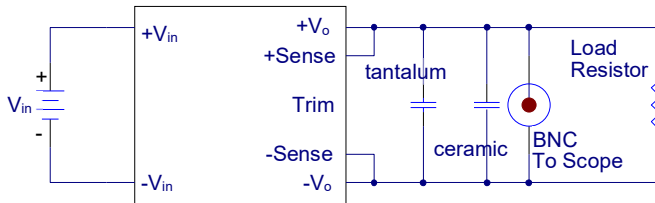

Output ripple and noise is measured with 10uF solid tantalum (for 24S05 with 330uF tantalum, 24S12 with 100uF tantalum and 48Vout with 10uF aluminum) and 1uF ceramic capacitors across the output.

6.12 Output Capacitance

For good transient response, low ESR output capacitors should be located close to the point of load. PCB design emphasizes low resistance and inductance tracks in consideration of high current applications. Output capacitors with their associated ESR values have an impact on loop stability and bandwidth. Must increased three or four times the minimum output capacitance when operating below -20°C and the absolute maximum value of CHB300W series' output capacitance, please refer to **Page5 maximum output capacitance** .For values larger than this please contact local CINCON's representative.



CHB300W Series Application Note V15

7. Safety & EMC

7.1 Input Fusing and Safety Considerations

The CHB300W series converters have no internal fuse. In order to achieve maximum safety and system protection, always use an input line fuse. It is recommended that the circuit have a transient voltage suppressor diode (TVS) across the input terminal to protect the unit against surge or spike voltage and input reverse voltage (as shown).

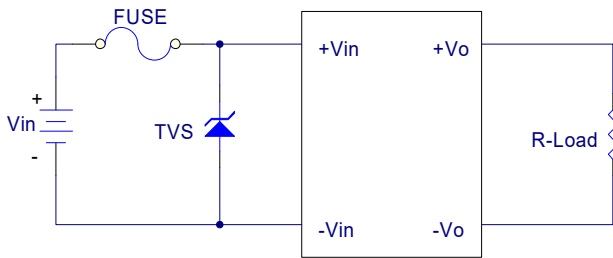

7.2 EMC Considerations

Suggested Circuits for Conducted EMI Class A

(1) EMI and conducted noise meet EN55032 Class A

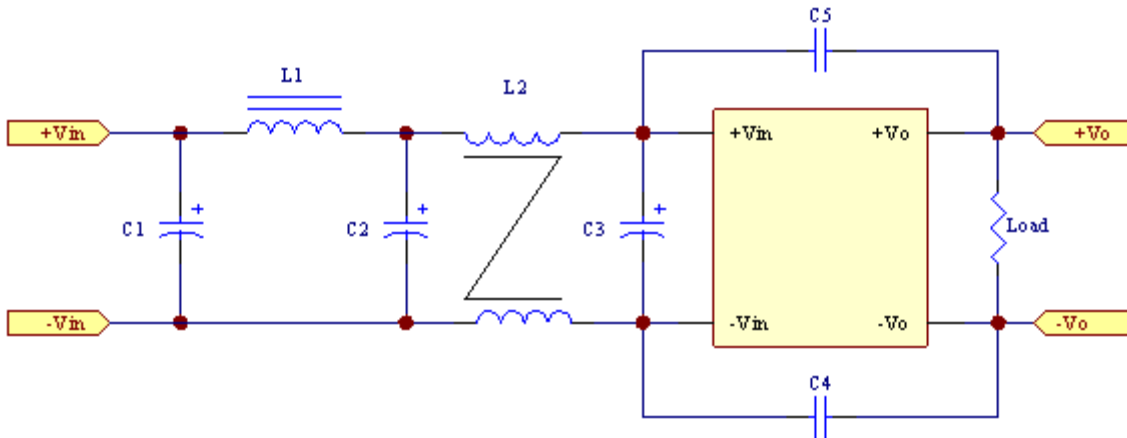

Model No.	Class A						
	C1	C2	C3	C4	C5	L1	L2
CHB300W-24S12	100uF/50V KY	220uF/100V PW	220uF/100V PW	1000pF/3KV	NC	1.0uH	0.2mH
CHB300W-24S24	220uF/100V KY	220uF/100V KY	220uF/100V KY	4700pF/2KV	NC	1.0uH	0.2mH
CHB300W-48S05	NC	220uF/100V KY	220uF/100V KY	NC	NC	1.0uH	0.2mH
CHB300W-48S28	NC	220uF/100V KY	220uF/100V KY	NC	NC	Short	0.2mH
CHB300W-48S48	NC	220uF/100V KY	220uF/100V KY	1000pF/2KV	1000pF/2KV	1.0uH	0.2mH

Note:

C1, C2, C3 is NIPPON-CHEMICON KY series or NICHICON PW series aluminum capacitor, C4, C5 are ceramic capacitors
L1: UPIA1207-1R0M 3L, L2: Core: SM CM20*12*10, 5turns double wire



CHB300W Series Application Note V15

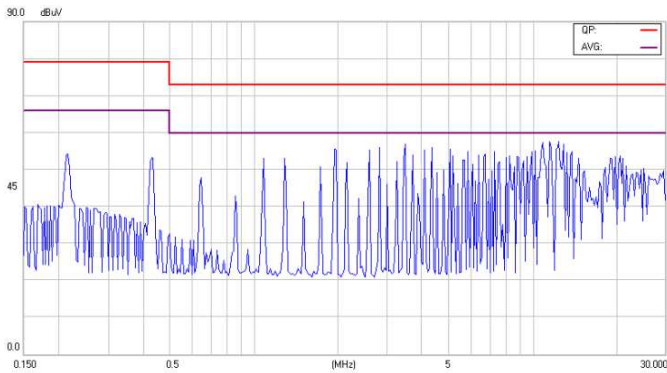

CHB300W-24S12 Class A Conducted Emissions
Test Condition: nominal input voltage, output at full load

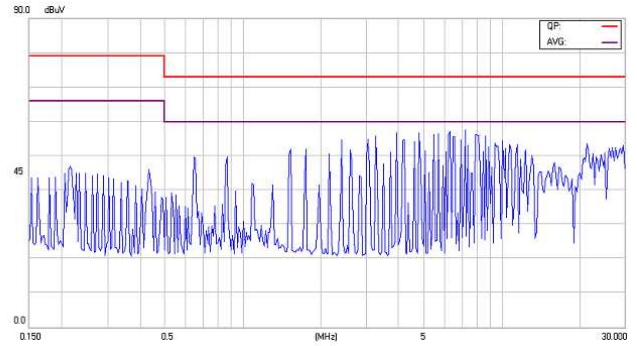

CHB300W-24S24 Class A Conducted Emissions
Test Condition: nominal input voltage, output at full load

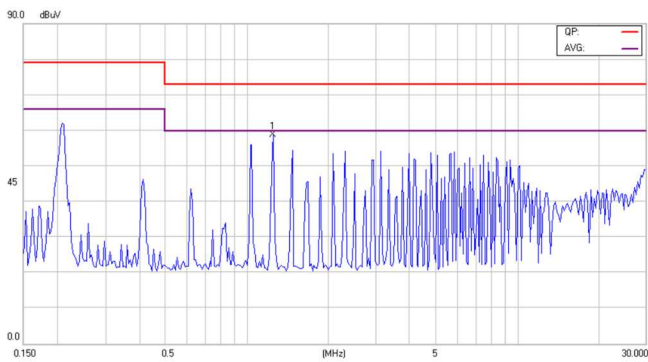

CHB300W-48S05 Class A Conducted Emissions
Test Condition: nominal input voltage, output at full load

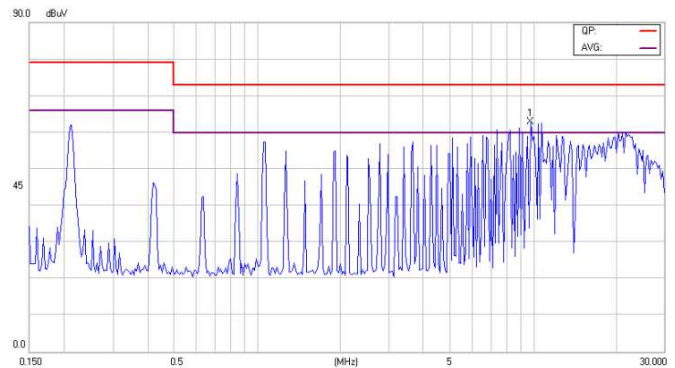

CHB300W-48S28 Class A Conducted Emissions
Test Condition: nominal input voltage, output at full load

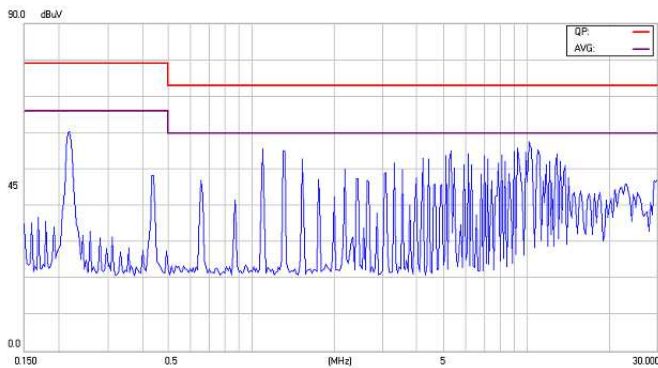

CHB300W-48S48 Class A Conducted Emissions
Test Condition: nominal input voltage, output at full load



CHB300W Series Application Note V15

8. Part Number

Format: CHB300W –II X OO L-Y

Parameter	Series	Nominal Input Voltage	Number of Outputs	Output Voltage	Remote On/Off Logic	Mounting Inserts
Symbol	CHB300W	II	X	OO	L	Y (Option)
Value	CHB300W	24 : 24 Volts 48 : 48 Volts	S : Single	05 : 05 Volts 12 : 12 Volts 15 : 15 Volts 24 : 24 Volts 28 : 28 Volts 48 : 48 Volts	None : Positive N : Negative	C : Clear Mounting Insert

Headquarters:

14F, No.306, Sec.4, Hsin Yi Rd.
 Taipei, Taiwan
 Tel: 886-2-27086210
 Fax: 886-2-27029852
 E-mail: sales@cincon.com
 Web Site: <https://www.cincon.com>

CINCON ELECTRONICS CO., LTD.

Factory:

No. 8-1, Fu Kung Rd.
 Fu Hsing Industrial Park
 Fu Hsing Hsiang,
 Chang Hua Hsien, Taiwan
 Tel: 886-4-7690261
 Fax: 886-4-7698031

Cincon North America:

1655 Mesa Verde Ave. Ste 180
 Ventura, CA 93003
 Tel: 805-639-3350
 Fax: 805-639-4101
 E-mail: info@cincon.com