



CQB150W-24(48)SXX Series Application Note V15

ISOLATED DC-DC CONVERTER CQB150W-24(48)SXX SERIES APPLICATION NOTE



Approved By:

Department	Approved By	Checked By	Written By
Research and Development Department	Jacky	Astray	Astray
Design Quality Department	Benny	JoJo	



CQB150W-24(48)SXX Series Application Note V15

Contents

1. Introduction	3
2. Pin Function Description	3
3. Connection for Standard Use	4
4. Test Set-Up	4
5. Recommend Layout, PCB Footprint and Soldering Information.....	5
6. Features and Functions	5
6.1 UVLO (Under Voltage Lock Out)	5
6.2 Over Current/Short Circuit Protection	5
6.3 Output Over Voltage Protection	6
6.4 Over Temperature Protection.....	6
6.5 Remote On/Off	6
6.6 Output Remote Sensing.....	7
6.7 Output Voltage Adjustment	8
7. Input / Output Considerations	9
7.1 Input Capacitance at the Power Module	9
7.2 Output Ripple and Noise	9
7.3 Output Capacitance	10
8. Series and Parallel Operation	10
8.1 Series Operation	10
8.2 Parallel Operation	10
8.3 Redundant Operation.....	11
9. Thermal Design.....	12
9.1 Operating Temperature Range	12
9.2 Convection Requirements for Cooling	12
9.3 Thermal Considerations	12
9.4 Power Derating	12
9.5 Quarter Brick Heat Sinks:.....	14
10. Safety & EMC	15
10.1 Input Fusing and Safety Considerations	15
10.2 EMC Considerations	15



CQB150W-24(48)SXX Series Application Note V15

1. Introduction

The CQB150W series of DC-DC converters offers 150 watts of output power @ single output voltages of 05, 12, 15, 24, 28, 48VDC with industry standard quarter-brick. It has a wide (4:1) input voltage range of 9 to 36VDC (24VDC nominal), 18 to 75VDC (48VDC nominal) and 2250VDC isolation.

Compliant with EN50155, EN45545. High efficiency up to 92%, allowing case operating temperature range of -40°C to 105°C. An optional heat sink is available to extend the full power range of the unit. Very low no load power consumption (10mA), an ideal solution for energy critical systems.

The standard control functions include remote on/off (positive or negative) and +10%, -10% (except for 15Vout +10%, -20%) adjustable output voltage.

Fully protected against input UVLO (under voltage lock out), output over-current, output over-voltage and over-temperature and continuous short circuit conditions.

CQB150W series is designed suitable for distributed power architectures, telecommunications, battery operated equipment, industrial and mobile equipment application.

2. Pin Function Description

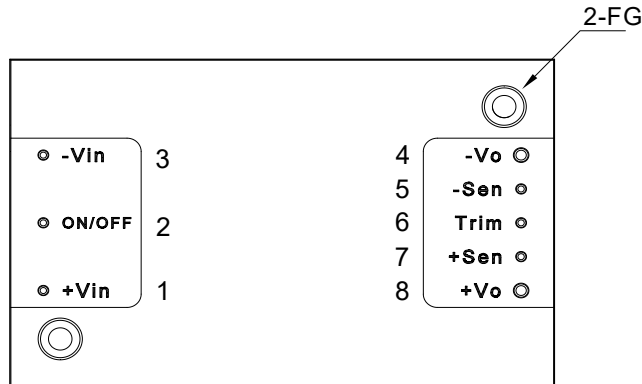

No	Label	Function	Description	Reference
1	+Vin	+V Input	Positive Supply Input	Section 7.1
2	ON/OFF	On/Off	External Remote On/Off Control	Section 6.5
3	-Vin	-V Input	Negative Supply Input	Section 7.1
4	-Vo	-V Output	Negative Power Output	Section 7.2/7.3
5	-Sen	-Sense	Negative Output Remote Sense	Section 6.6
6	Trim	Trim	External Output Voltage Adjustment	Section 6.7
7	+Sen	+Sense	Positive Output Remote Sense	Section 6.6
8	+Vo	+V Output	Positive Power Output	Section 7.2/7.3
--	--	Mounting Insert	Mounting Insert (FG)	Section 9.5

Note: Base plate can be connected to FG through M3 threaded mounting insert. Recommended torque 3Kgf-cm.



CQB150W-24(48)SXX Series Application Note V15

3. Connection for Standard Use

The connection for standard use is shown below. An external input capacitor (C1) 220uF for all models is recommended to reduce input ripple voltage. External output capacitors (C2, C3) are recommended to reduce output ripple and noise, 10uF aluminum and 1uF ceramic capacitor for 48Vout, and 10uF tantalum and 1uF ceramic capacitor for other models.

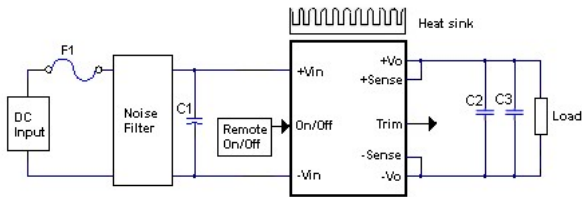

Symbol	Component	Reference
F1	Input fuse	Section 10.1
C1	External capacitor on input side	Note Section 7.1
C2, C3	External capacitor on the output side	Section 7.2/7.3
Noise Filter	External input noise filter	Section 10.2
Remote On/Off	External Remote On/Off control	Section 6.5
Trim	External output voltage adjustment	Section 6.7
Heat sink	External heat sink	Section 9.2/9.3/9.4/9.5
+Sense/-Sense	--	Section 6.6

Note:

If the impedance of input line is high, C1 capacitance must be more than above. Use more than two recommended capacitor above in parallel when ambient temperature becomes lower than -20°C.

4. Test Set-Up

The basic test set-up to measure parameters such as efficiency and load regulation is shown below. When testing the modules under any transient conditions please ensure that the transient response of the source is sufficient to power the equipment under test. We can calculate:

- Efficiency
- Load regulation and line regulation

The value of efficiency is defined as:

$$\eta = \frac{V_o \times I_o}{V_{in} \times I_{in}} \times 100\%$$

Where:

- V_o is output voltage,
- I_o is output current,
- V_{in} is input voltage,
- I_{in} is input current.

The value of load regulation is defined as:

$$\text{Load reg.} = \frac{V_{FL} - V_{NL}}{V_{NL}} \times 100\%$$

Where:

- V_{FL} is the output voltage at full load.
- V_{NL} is the output voltage at no load.

The value of line regulation is defined as:

$$\text{Line reg.} = \frac{V_{HL} - V_{LL}}{V_{LL}} \times 100\%$$

Where:

- V_{HL} is the output voltage of maximum input voltage at full load.
- V_{LL} is the output voltage of minimum input voltage at full load.

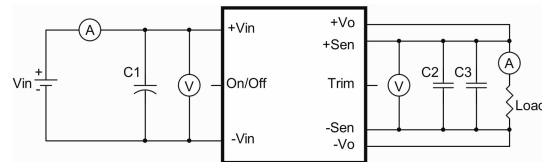

CQB150W Series Test Setup

C1: 220uF/100V ESR<0.035Ω

C2: 1uF/1210 ceramic capacitor

C3: 10uF aluminum capacitor for 48Vout.
10uF tantalum capacitor for others.



CQB150W-24(48)SXX Series Application Note V15

5. Recommend Layout, PCB Footprint and Soldering Information

The system designer or end user must ensure that metal and other components in the vicinity of the converter meet the spacing requirements for which the system is approved. Low resistance and inductance PCB layout traces are the norm and should be used where possible. Due consideration must also be given to proper low impedance tracks between power module, input and output grounds.

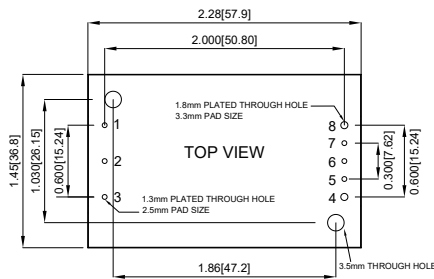

Clean the soldered side of the module with a brush, prevent liquid from getting into the module. Do not clean by soaking the module into liquid. Do not allow solvent to come in contact with product labels or resin case as this may change the color of the resin case or cause deletion of the letters printed on the product label. After cleaning, dry the modules well.

The suggested soldering iron is 450°C for up to 5seconds (less than 50W). Furthermore, the recommended soldering profile is shown below, and PCB layout is referring to Section 10.2.

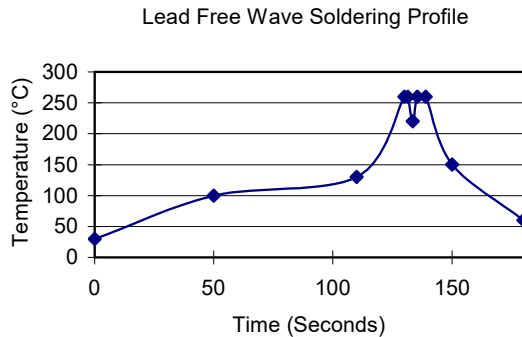

6. Features and Functions

6.1 UVLO (Under Voltage Lock Out)

Input under voltage lockout is standard on the CQB150W series unit. The unit will shut down when the input voltage drops below a threshold, and the unit will operate when the input voltage goes above the upper threshold.

CQB150W-24SXX
Iin Vs Vin

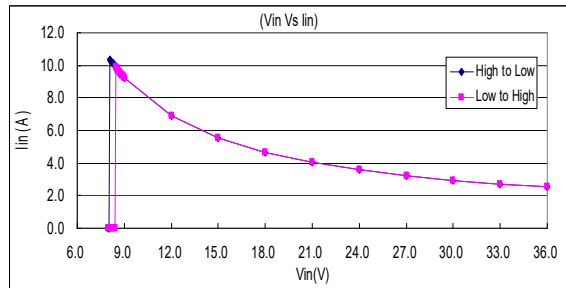

CQB150W-48SXX
Iin Vs Vin

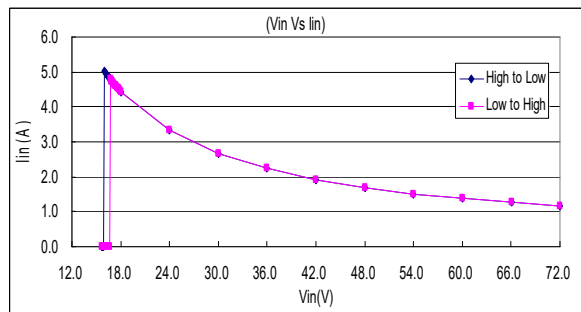

6.2 Over Current/Short Circuit Protection

All models have internal over current and continuous short circuit protection. The unit operates normally once the fault condition is removed. At the point of current limit inception, the converter will go into hiccup mode protection.

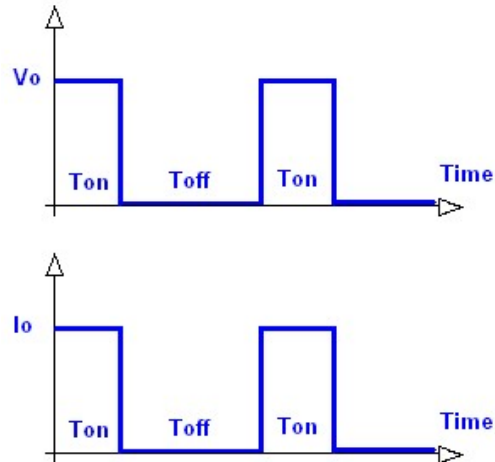



CQB150W-24(48)SXX Series Application Note V15

6.3 Output Over Voltage Protection

The output over voltage protection consists of circuitry that internally limits the output voltage. If more accurate output over voltage protection is required, then an external circuit can be used via the remote on/off pin.

Note: Please note that device inside the power supply might fail when voltage more than rate output voltage is applied to output pin. This could happen when the customer tests the over voltage protection of unit. OVP can be tested by using the TRIM UP function. Consult us for more information.

6.4 Over Temperature Protection

These modules have an over temperature protection circuit to safeguard against thermal damage. Shutdown occurs with the maximum case reference temperature is exceeded. The module will restart when the case temperature falls below over temperature recovery threshold. Please measure case temperature of the center part of aluminum base plate.

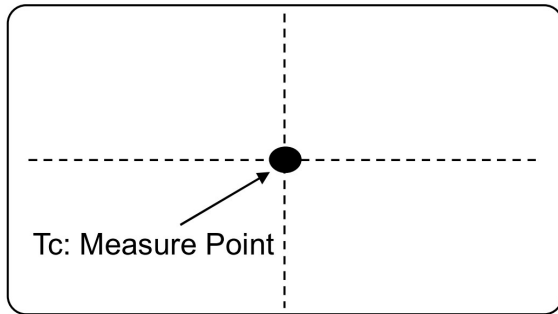
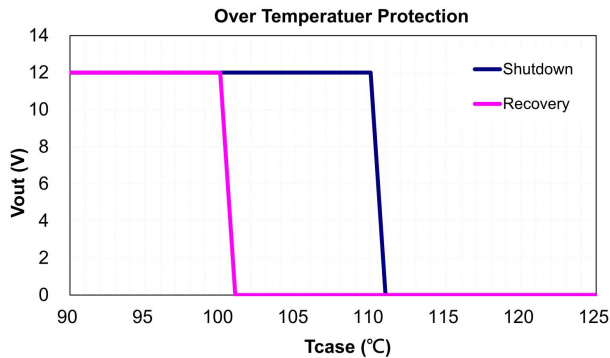

6.5 Remote On/Off

The CQB150W series allows the user to switch the module on and off electronically with the remote On/Off feature. All models are available in "positive logic" and "negative logic" (optional) versions. The converter turns on if the remote On/Off pin is high (>3.5Vdc to 75Vdc or open circuit). Setting the pin low (0 to <1.2Vdc, except M2 Series is 0 to <1.0Vdc) will turn the converter off. The signal level of the remote On/Off input is defined with respect to ground.

If not using the remote On/Off pin, leave the pin open (converter will be on).

Models with part number suffix "N" are the "negative logic" remote On/Off version. The unit turns off if the remote On/Off pin is high (>3.5Vdc to 75Vdc or open circuit). The converter turns on if the On/Off pin input is low (0 to <1.2Vdc, except M2 Series is 0 to <1.0Vdc). Note that the converter is off by default.

Logic State (Pin 2)	Negative Logic	Positive Logic
Logic Low	Module on	Module off
Logic High	Module off	Module on

The converter remote On/Off circuit built-in on input side. The ground pin of input side Remote On/Off circuit is -Vin pin. Inside connection sees below.

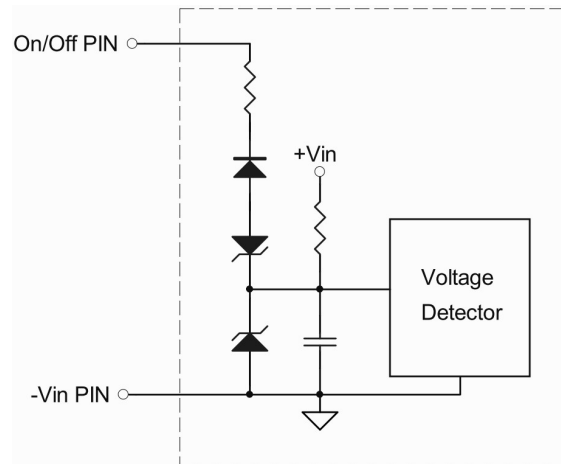

Connection examples see below.

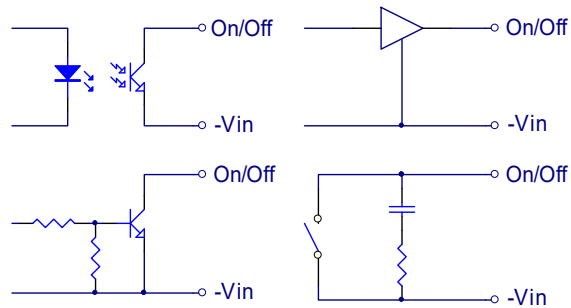

Remote On/Off Connection Example



CQB150W-24(48)SXX Series Application Note V15

6.6 Output Remote Sensing

The CQB150W series converter has the capability to remotely sense both lines of its output. This feature moves the effective output voltage regulation point from the output of the unit to the point of connection of the remote sense pins. This feature automatically adjusts the real output voltage of the CQB150W series in order to compensate for voltage drops in distribution and maintain a regulated voltage at the point of load. The remote-sense voltage range is:

$$[(+V_{out}) - (-V_{out})] - [(+Sense) - (-Sense)] \leq 10\% \text{ of } V_{o_nominal}$$

When remote sense is in use, the sense should be connected by twisted-pair wire or shield wire. If the sensing patterns short, heavy current flows and the pattern may be damaged. Output voltage might become unstable because of impedance of wiring and load condition when length of wire is exceeding 400mm. This is shown in the schematic below.

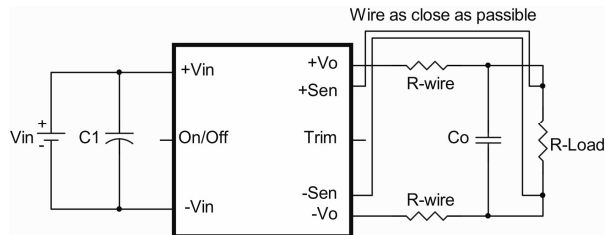

If the remote sense feature is not to be used, the sense pins should be connected locally. The +Sense pin should be connected to the +Vout pin at the module and the -Sense pin should be connected to the -Vout pin at the module. Wire between +Sense and +Vout and between -Sense and -Vout as short as possible. Loop wiring should be avoided. The converter might become unstable by noise coming from poor wiring. This is shown in the schematic below.

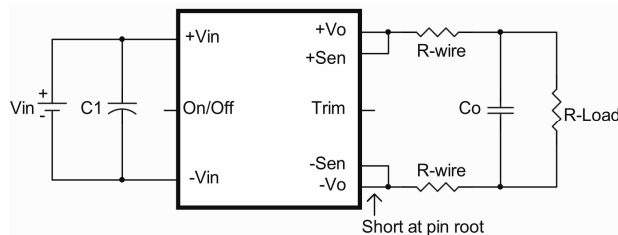

Note:

Although the output voltage can be varied (increased or decreased) by both remote sense and trim, the maximum variation for the output voltage is the larger of the two values not the sum of the values. The output power delivered by the module is defined as the voltage at the output terminals multiplied by the output current. Using remote sense and trim can cause the output voltage to increase and consequently increase the power output of the module if output current remains unchanged. Always ensure that the output power of the module remains at or below the maximum rated power. Also be aware that if $V_{o,set}$ is below nominal value, $P_{out,max}$ will also decrease accordingly because $I_{o,max}$ is an absolute limit. Thus, $P_{out,max} = V_{o,set} \times I_{o,max}$ is also an absolute limit.



CQB150W-24(48)SXX Series

Application Note V15

6.7 Output Voltage Adjustment

Output may be externally trimmed ($\pm 10\%$, except 15Vout is +10%, -20%) with a fixed resistor or an external trim pot as shown (optional). Model specific formulas for calculating trim resistors are available upon request as a separate document.

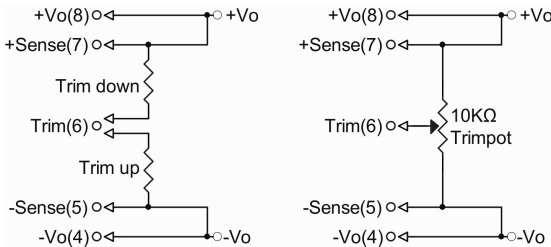

In order to trim the voltage up or down, one needs to connect the trim resistor either between the trim pin and -Sense for trim-up or between trim pin and +Sense for trim-down. The output voltage trim range is ($\pm 10\%$, except 15Vout is +10%, -20%). This is shown:

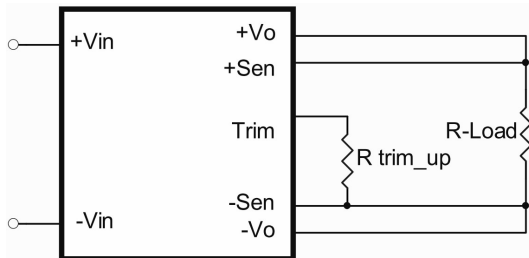

Trim-up Voltage Setup

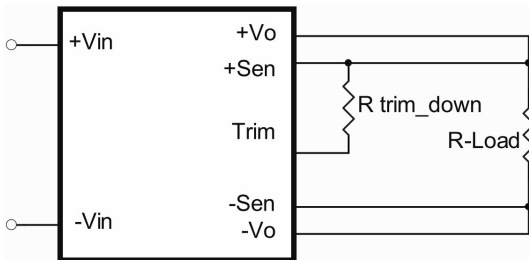

Trim-down Voltage Setup

The value of R_{trim_up} defined as:

For $V_o=5V$ R_{trim_up} decision:

$$R_{trim_up} = \frac{R1V_r}{V_o - V_{o,nom}} - R2 \text{ (K}\Omega\text{)}$$

For others R_{trim_up} decision:

$$R_{trim_up} = \left[\frac{R1(V_r - V_f \left(\frac{R2}{R2 + R3} \right))}{(V_o - V_{o,nom})} \right] - \frac{R2R3}{R2 + R3} \text{ (K}\Omega\text{)}$$

Where:

R_{trim_up} is the external resistor in $K\Omega$.

$V_{o,nom}$ is the nominal output voltage.

V_o is the desired output voltage.

$R1, R2, R3$ and V_r are internal to the unit and are defined in Table 1.

Table 1 – Trim up and Trim down Resistor Values

Model Number	Output Voltage(V)	R1 (K Ω)	R2 (K Ω)	R3 (K Ω)	V _r (V)	V _f (V)
CQB150W-XXS05	5.0	2.32	3.3	0	2.5	0
CQB150W-XXS12	12.0	9.1	51	5.1	2.5	0.46
CQB150W-XXS15	15.0	12	36	8.25	2.5	0.46
CQB150W-XXS24	24.0	20	100	7.5	2.5	0.46
CQB150W-XXS28	28.0	23.7	150	6.2	2.5	0.46
CQB150W-XXS48	48.0	36	270	5.1	2.5	0.46

For example, to trim-up the output voltage of 12V module (CQB150W-48S12) by 5% to 12.6V, R_{trim_up} is calculated as follows:

$$V_o - V_{o,nom} = 12.6 - 12 = 0.6V$$

$$R1 = 9.1 \text{ K}\Omega, R2 = 51 \text{ K}\Omega, R3 = 5.1 \text{ K}\Omega,$$

$$V_r = 2.5 \text{ V}, V_f = 0.46 \text{ V}$$

$$R_{trim_up} = \left[\frac{18.944}{0.6} \right] - 4.636 = 26.94 \text{ (K}\Omega\text{)}$$

The typical value of R_{trim_up}

Trim up (%)	05V	12V	15V	24V	28V	48V
	R_{trim_up} (K Ω)					
1%	112.7	153.2	163.3	165.7	168.3	148.6
2%	54.70	74.30	78.32	79.36	81.16	71.81
3%	35.37	47.99	49.98	50.58	52.12	46.21
4%	25.70	34.83	35.80	36.19	37.60	33.40
5%	19.90	26.94	27.30	27.56	28.86	25.72
6%	16.03	21.68	21.63	21.80	23.08	20.60
7%	13.27	17.92	17.58	17.69	18.93	16.94
8%	11.20	15.10	14.55	14.61	15.82	14.20
9%	9.589	12.91	12.18	12.21	13.40	12.07
10%	8.300	11.15	10.29	10.29	11.47	10.36

The value of R_{trim_down} defined as:

$$R_{trim_down} = \frac{R1 \times (V_o - V_r)}{V_{o,nom} - V_o} - R2 \text{ (K}\Omega\text{)}$$

Where:

R_{trim_down} is the external resistor in $K\Omega$.

$V_{o,nom}$ is the nominal output voltage.

V_o is the desired output voltage.

$R1, R2, R3$ and V_r are internal to the unit and are defined in Table 1.



CQB150W-24(48)SXX Series Application Note V15

For example: to trim-down the output voltage of 12V module (CQB150W-48S12) by 5% to 11.4V, R_{trim_down} is calculated as follows:

$$V_{o_nom} - V_o = 12 - 11.4 = 0.6 \text{ V}$$

$$R1 = 9.1 \text{ K}\Omega, R2 = 51 \text{ K}\Omega, V_r = 2.5 \text{ V}$$

$$R_{trim_down} = \frac{9.1 \times (11.4 - 2.5)}{0.6} - 51 = 83.98 \text{ (K}\Omega)$$

The typical value of R_{trim_down}

Trim down (%)	05V	12V	24V	28V	48V
	R_{trim_down} (K Ω)				
1%	110.4	660.3	1671	1984	3106
2%	52.38	300.1	775.8	905.5	1400
3%	33.05	180.0	477.2	545.8	831.5
4%	23.38	120.0	327.9	365.9	547.1
5%	17.58	83.99	238.3	258.0	376.5
6%	13.71	59.97	178.6	186.0	262.8
7%	10.95	42.82	136.0	134.6	181.5
8%	8.880	29.95	104.0	96.10	120.6
9%	7.269	19.95	79.07	66.12	73.17
10%	5.980	11.94	59.17	42.14	35.25

The 15Vout typical value of R_{trim_down}

Trim down (%)	15V	Trim down (%)	15V
	R_{trim_down} (K Ω)		R_{trim_down} (K Ω)
1%	952.0	11%	42.91
2%	452.0	12%	35.33
3%	285.3	13%	28.92
4%	202.0	14%	23.43
5%	152.0	15%	18.67
6%	118.7	16%	14.50
7%	94.86	17%	10.82
8%	77.00	18%	7.56
9%	63.11	19%	4.63
10%	52.00	20%	2.00

7. Input / Output Considerations

7.1 Input Capacitance at the Power Module

The converters must be connected to low AC source impedance. To avoid problems with loop stability source inductance should be low. Also, the input capacitors (C_{in}) should be placed close to the converter input pins to de-couple distribution inductance. However, the external input capacitors are chosen for suitable ripple handling capability. Low ESR capacitors are good choice. Circuit as shown as below represents typical measurement methods for reflected ripple current. $C1$ and $L1$ simulate a typical DC source impedance. The input reflected-ripple current is measured by current

probe to oscilloscope with a simulated source inductance ($L1$).

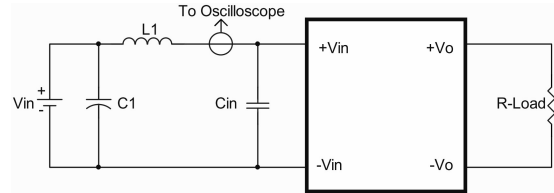

$L1$: 12 μ H

$C1$: 470 μ F ESR<0.1ohm @100KHz

C_{in} : 470 μ F ESR<0.7ohm @100KHz

7.2 Output Ripple and Noise

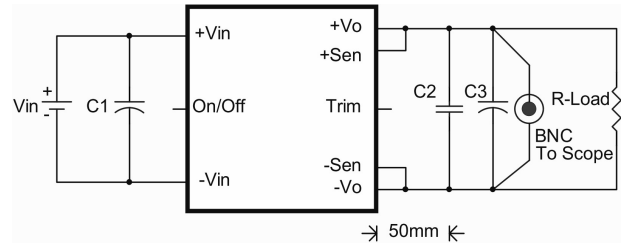

Output ripple and noise measured with 10 μ F aluminum and 1 μ F ceramic capacitor across output for 48Vout and with 10 μ F tantalum and 1 μ F ceramic capacitor for others. A 20 MHz bandwidth oscilloscope is normally used for the measurement.

The conventional ground clip on an oscilloscope probe should never be used in this kind of measurement. This clip, when placed in a field of radiated high frequency energy, acts as an antenna or inductive pickup loop, creating an extraneous voltage that is not part of the output noise of the converter.





CQB150W-24(48)SXX Series Application Note V15

Another method is shown in below, in case of coaxial-cable/BNC is not available. The noise pickup is eliminated by pressing scope probe ground ring directly against the -Vout terminal while the tip contacts the +Vout terminal. This makes the shortest possible connection across the output terminals.

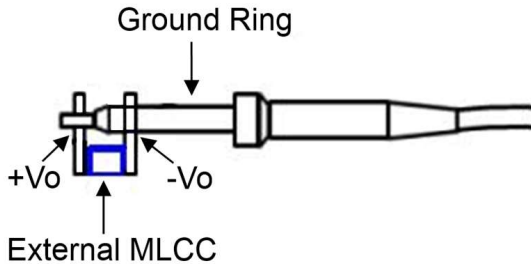

7.3 Output Capacitance

The CQB150W series converters provide unconditional stability with or without external capacitors. For good transient response, low ESR output capacitors should be located close to the point of load (<100mm). PCB design emphasizes low resistance and inductance tracks in consideration of high current applications. Output capacitors with their associated ESR values have an impact on loop stability and bandwidth. Cincon's converters are designed to work with load capacitance to see specifications.

8. Series and Parallel Operation

8.1 Series Operation

Series operation is possible by connecting the outputs two or more units. Connection is shown in below. The output current in series connection should be lower than the lowest rate current in each power module.

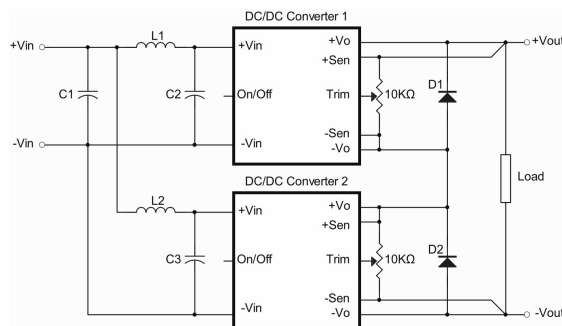

Simple Series Operation Connect Circuit

L1, L2: 1.0uH
C1, C2, C3: 220uF/100V ESR<0.035Ω

Note:

1. If the impedance of input line is high, C1, C2, C3 capacitance must be more than above. Use more than

two recommended capacitor above in parallel when ambient temperature becomes lower than -20°C.

2. Recommend schottky diode (D1, D2) be connected across the output of each series connected converter, so that if one converter shuts down for any reason, then the output stage won't be thermally overstressed. Without this external diode, the output stage of the shut-down converter could carry the load current provided by the other series converters, with its MOSFETs conducting through the body diodes. The MOSFETs could then be overstressed and fail. The external diode should be capable of handling the full load current for as long as the application is expected to run with any unit shut down.

Series for ±output operation is possible by connecting the outputs two units, as shown in the schematic below.

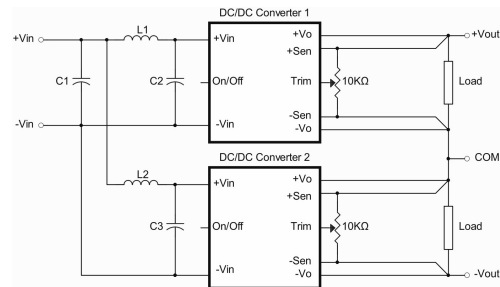

Simple ±Output Operation Connect Circuit

L1, L2: 1.0uH
C1, C2, C3: 220uF/100V ESR<0.035Ω

Note:

If the impedance of input line is high, C1, C2, C3 capacitance must be more than above. Use more than two recommended capacitor above in parallel when ambient temperature becomes lower than -20°C.

8.2 Parallel Operation

The CQB150W series parallel operation is **not** possible.



CQB150W-24(48)SXX Series Application Note V15

8.3 Redundant Operation

Parallel for redundancy operation is possible by connecting the units as shown in the schematic below. The current of each converter become unbalance by a slight difference of the output voltage. Make sure that the output voltage of units of equal value and the output current from each power supply does not exceed the rate current. Suggest use an external potentiometer to adjust output voltage from each power supply.

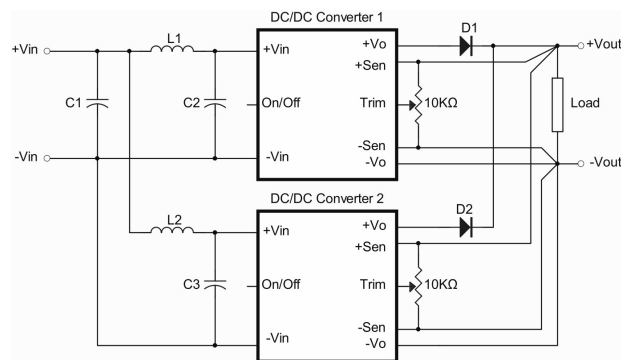

Simple Redundant Operation Connect Circuit

L1, L2: 1.0uH

C1, C2, C3: 220uF/100V ESR<0.035Ω

Note:

If the impedance of input line is high, C1, C2, C3 capacitance must be more than above. Use more than two recommended capacitor above in parallel when ambient temperature becomes lower than -20°C.



CQB150W-24(48)SXX Series Application Note V15

9. Thermal Design

9.1 Operating Temperature Range

The CQB150W series converters can be operated within a wide case temperature range of -40°C to 105°C. Consideration must be given to the derating curves when ascertaining maximum power that can be drawn from the converter. The maximum power drawn from open quarter brick models is influenced by usual factors, such as:

- Input voltage range
- Output load current
- Forced air or natural convection
- Heat sink optional

9.2 Convection Requirements for Cooling

To predict the approximate cooling needed for the quarter brick module, refer to the power derating curves in **section 9.4**. These derating curves are approximations of the ambient temperatures and airflows required to keep the power module temperature below its maximum rating. Once the module is assembled in the actual system, the module's temperature should be monitored to ensure it does not exceed 105°C as measured at the center of the top of the case (thus verifying proper cooling).

9.3 Thermal Considerations

The power module operates in a variety of thermal environments; however, sufficient cooling should be provided to help ensure reliable operation of the unit. Heat is removed by conduction, convection, and radiation to the surrounding environment. The example is presented in **section 9.4**. The power output of the module should not be allowed to exceed rated power ($V_{o_set} \times I_{o_max}$).

9.4 Power Derating

The operating case temperature range of CQB150W series is -40°C to +105°C. When operating the CQB150W series, proper derating or cooling is needed. The maximum case temperature under any operating condition should not exceed 105°C.

The following curve is the de-rating curve of CQB150W series without heat sink.

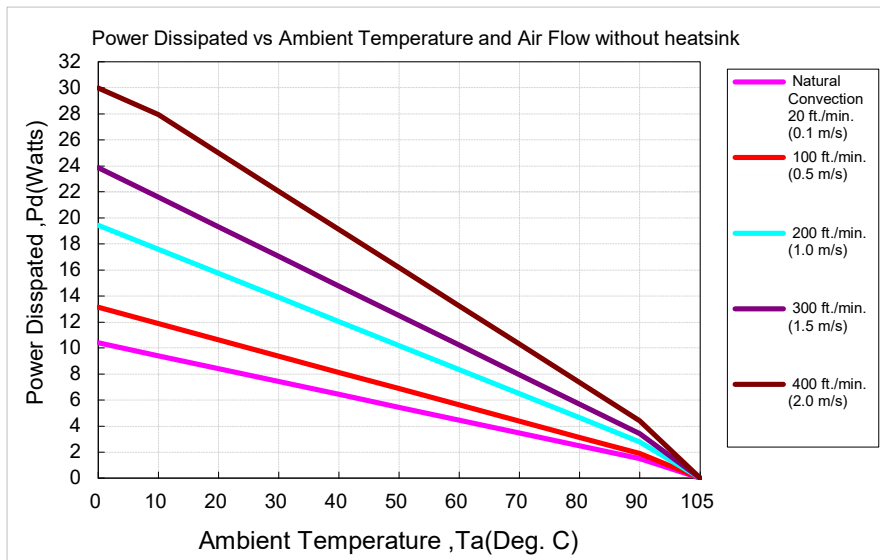

AIR FLOW RATE	TYPICAL R_{ca}
Natural Convection 20ft./min. (0.1m/s)	10.1 °C/W
100 ft./min. (0.5m/s)	8.0 °C/W
200 ft./min. (1.0m/s)	5.4 °C/W
300 ft./min. (1.5m/s)	4.4 °C/W
400 ft./min. (2.0m/s)	3.4 °C/W



CQB150W-24(48)SXX Series Application Note V15

Example:

What is the minimum airflow necessary for a CQB150W-48S12 operating at nominal line voltage, an output current of 12.5A, and a maximum ambient temperature of 50°C?

Solution:

Given: $V_{in}= 48V_{dc}$, $V_o= 12V_{dc}$, $I_o= 12.5A$

Determine Power dissipation (P_d): $P_d= P_i-P_o= P_o(1-\eta)/\eta$, $P_d= 12 \times 12.5 \times (1-0.9)/0.9= 16.67Watts$

Determine airflow: Given: $P_d= 16.67W$ and $T_a= 40^\circ C$

Check Power Derating curve: Minimum airflow= 400 ft./min.

Verify:

Maximum temperature rise is $\Delta T= P_d \times R_{ca} = 16.67 \times 3.4= 56.68^\circ C$

Maximum case temperature is $T_c = T_a + \Delta T= 96.68^\circ C < 105^\circ C$

Where:

The R_{ca} is thermal resistance from case to ambient environment.

T_a is ambient temperature and T_c is case temperature.

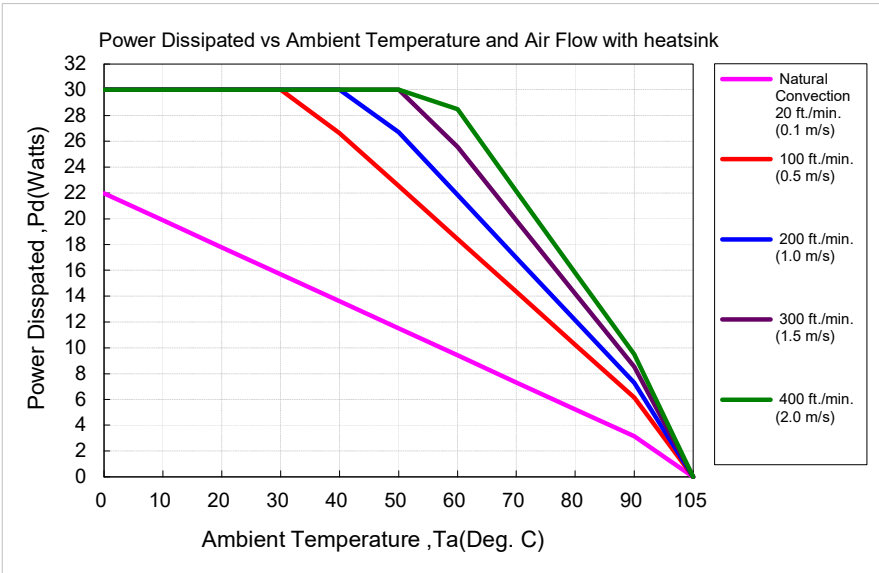

AIR FLOW RATE	TYPICAL R_{ca}
Natural Convection 20ft./min. (0.1m/s)	4.78 °C/W
100 ft./min. (0.5m/s)	2.44 °C/W
200 ft./min. (1.0m/s)	2.06 °C/W
300 ft./min. (1.5m/s)	1.76 °C/W
400 ft./min. (2.0m/s)	1.58 °C/W

Example with heat sink QBT210 (M-C421):

What is the minimum airflow necessary for a CQB150W-24S05 operating at nominal line voltage, an output current of 30A, and a maximum ambient temperature of 40°C?

Solution:

Given: $V_{in}= 24V_{dc}$, $V_o= 5V_{dc}$, $I_o= 30A$

Determine Power dissipation (P_d): $P_d= P_i-P_o= P_o(1-\eta)/\eta$, $P_d= 5.0 \times 30 \times (1-0.89)/0.89= 18.54Watts$

Determine airflow: Given: $P_d= 18.54W$ and $T_a = 40^\circ C$

Check above Power de-rating curve: Minimum airflow= 100 ft./min

Verify:

Maximum temperature rise is $\Delta T= P_d \times R_{ca}= 18.54 \times 2.44= 45.24^\circ C$

Maximum case temperature is $T_c= T_a + \Delta T= 84.24^\circ C < 105^\circ C$

Where:

The R_{ca} is thermal resistance from case to ambient environment.

T_a is ambient temperature and T_c is case temperature.



CQB150W-24(48)SXX Series Application Note V15

9.5 Quarter Brick Heat Sinks:

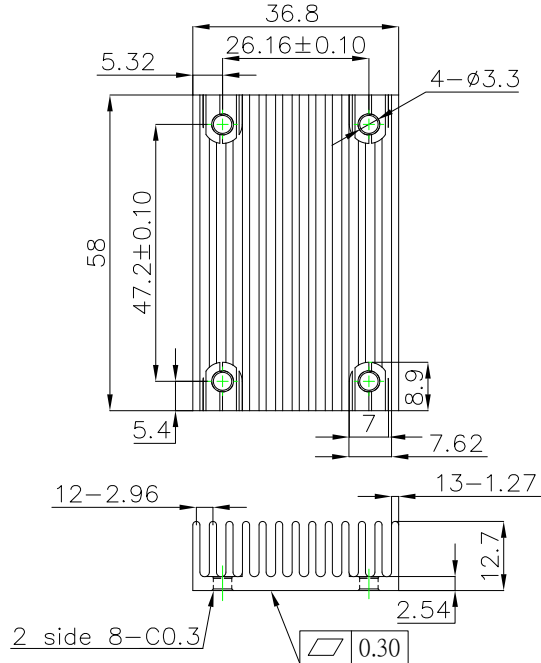
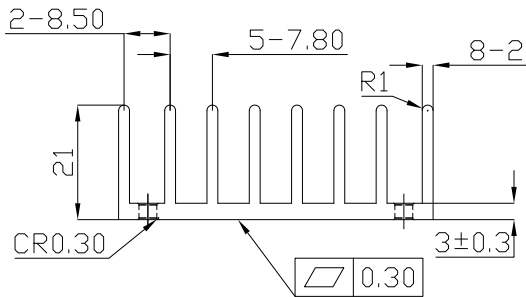
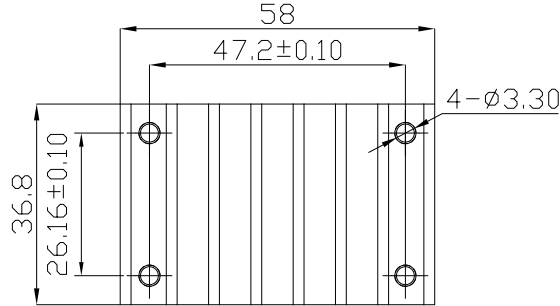

All Dimensions in mm

QBT210 (M-C421) G6620510201 Transverse Heat Sink

- Rca: 4.78°C/W (typ.), At natural convection
- 2.44°C/W (typ.), At 100LFM
- 2.06°C/W (typ.), At 200LFM
- 1.76°C/W (typ.), At 300LFM
- 1.58°C/W (typ.), At 400LFM

QBL127 (M-C448) G6620570202 Longitudinal Heat Sink

- Rca: 5.61°C/W (typ.), At natural convection
- 4.01°C/W (typ.), At 100LFM
- 3.39°C/W (typ.), At 200LFM
- 2.86°C/W (typ.), At 300LFM
- 2.49°C/W (typ.), At 400LFM

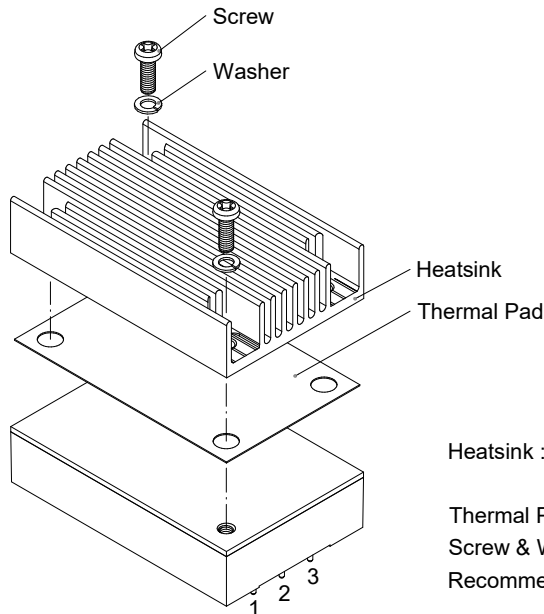

- Heatsink : QBL127 (M-C448)
- QBT210 (M-C421)
- Thermal Pad PQ01: SZ35.8x56.9x0.25mm
- Screw & Washer K308W: M3x8L & WS3.2N
- Recommended torque 3-5 Kgf-cm



CQB150W-24(48)SXX Series Application Note V15

10. Safety & EMC

10.1 Input Fusing and Safety Considerations

The CQB150W series converters have no internal fuse. In order to achieve maximum safety and system protection, always use an input line fuse. We recommended a 30A time delay fuse for 24V_{in} models, and 15A for 48V_{in} models. It is recommended that the circuit have a transient voltage suppressor diode (TVS) across the input terminal to protect the unit against surge or spike voltage and input reverse voltage (as shown).

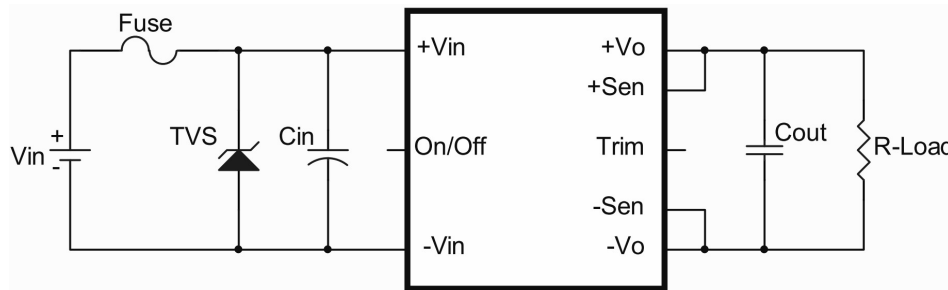

The external input capacitor (C_{in}) and transient voltage suppressor diode (TVS) are required if CQB150Wseries has to meet EN61000-4-4, EN61000-4-5.

The C_{in} recommended a 470uF/100V (Nippon Chemi-Con KY series) aluminum capacitor. And the TVS recommended SMDJ40CA for 24V_{in} models, and SMDJ78A for 48V_{in} models.

10.2 EMC Considerations

EMI Test standard: EN55022 / EN55032 Class A Conducted Emission

Test Condition: Input Voltage: Nominal, Output Load: Full Load

(1) EMI and conducted noise meet EN55032 Class A:

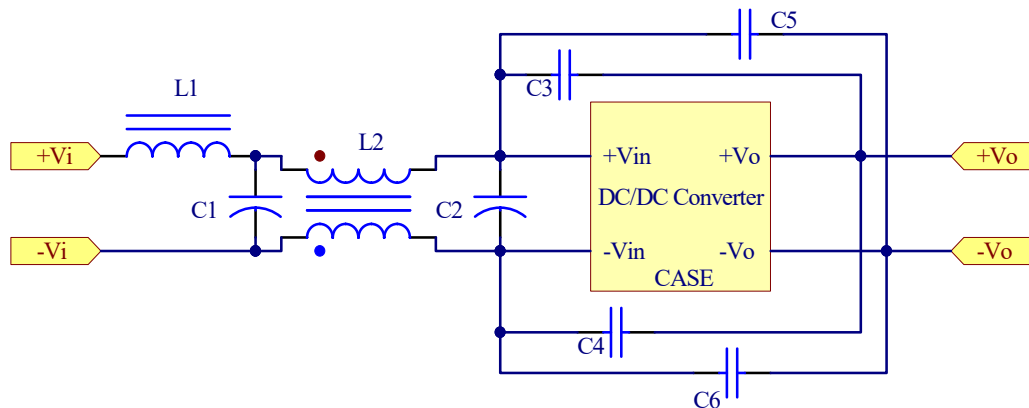
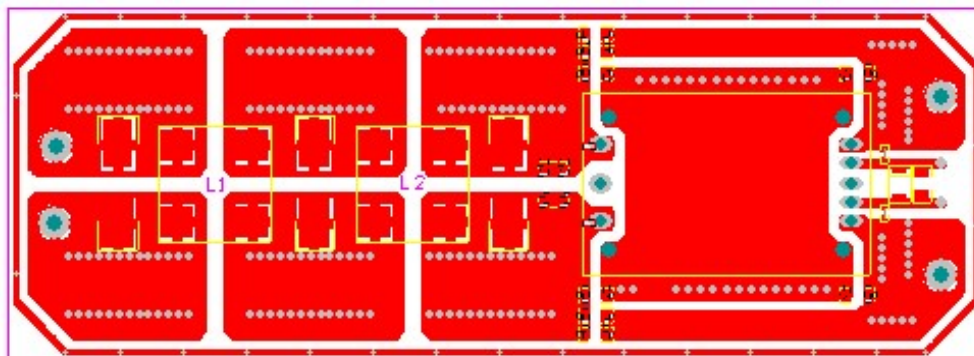

Figure1 Connection circuit for conducted EMI Class A testing



CQB150W-24(48)SXX Series Application Note V15



EMI Test Board Top Side

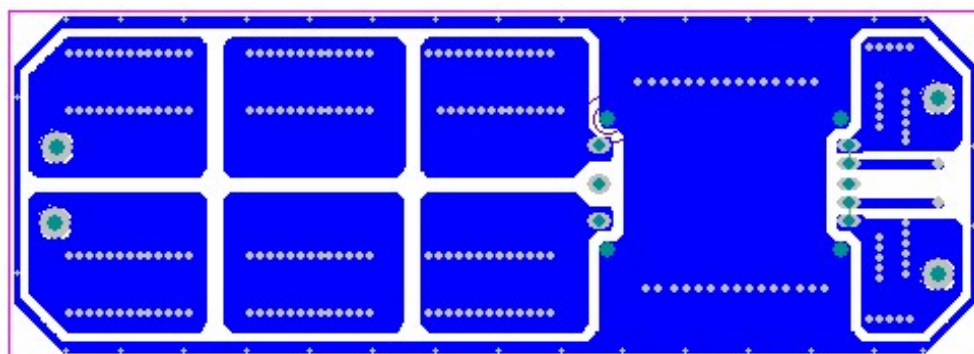

EMI Test Board Bottom Side

Components value:

Model No.	C1	C2	C3	C4	C5	C6	L1	L2
CQB150W-24S05	470uF/50V	470uF/50V	2200pF	N.C.	N.C.	2200pF	Short	0.5mH
CQB150W-24S12	470uF/50V	470uF/50V	2200pF	N.C.	N.C.	2200pF	Short	0.5mH
CQB150W-24S15	470uF/50V	470uF/50V	2200pF	N.C.	N.C.	2200pF	Short	0.5mH
CQB150W-24S24	470uF/50V	470uF/50V	2200pF	N.C.	N.C.	2200pF	Short	0.5mH
CQB150W-24S28	470uF/50V	470uF/50V	2200pF	N.C.	N.C.	2200pF	Short	0.5mH
CQB150W-24S48	470uF/50V	470uF/50V	4700pF	N.C.	N.C.	4700pF	Short	0.5mH
CQB150W-48S05	220uF/100V	220uF/100V	2200pF	N.C.	N.C.	2200pF	Short	0.5mH
CQB150W-48S12	220uF/100V	220uF/100V	2200pF	N.C.	N.C.	2200pF	Short	0.5mH
CQB150W-48S15	220uF/100V	220uF/100V	3300pF	N.C.	N.C.	3300pF	Short	0.5mH
CQB150W-48S24	220uF/100V	220uF/100V	2200pF	N.C.	N.C.	2200pF	Short	0.5mH
CQB150W-48S28	220uF/100V	220uF/100V	2200pF	N.C.	N.C.	2200pF	Short	0.5mH
CQB150W-48S48	220uF/100V	220uF/100V	4700pF	N.C.	N.C.	4700pF	Short	0.5mH

Note:

C1, C2 NIPPON CHEMI-CON KY series aluminum capacitors, C3, C4, C5, C6 is ceramic capacitors.

C1, C2: 470uF/50V (NIPPON CHEMI-CON EKY-500E□□471MK20S) or equivalent.

220uF/100V (NIPPON CHEMI-CON EKY-101E□□221MK25S) or equivalent.

C3, C6: 2200pF (MURATA KX Series DC1E3KX222MA4BN01F) or equivalent.

4700pF (MURATA KX Series DC1E3KX472MA4BN01F) or equivalent.

L2: SC-15-05J (TOKIN) or equivalent.



CQB150W-24(48)SXX Series Application Note V15

Conducted Emission (Input):

Conducted Class A of CQB150W-24S05
Line

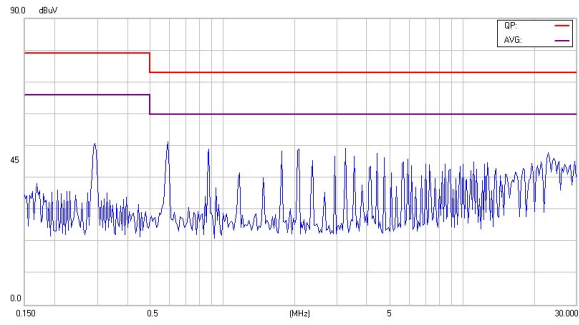

Neutral

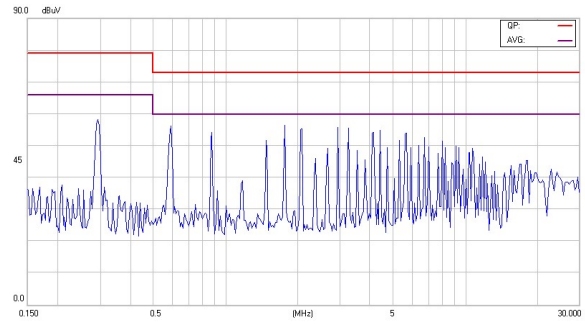

Conducted Class A of CQB150W-24S12
Line

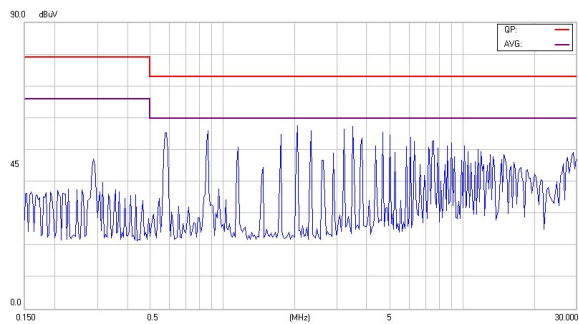

Neutral

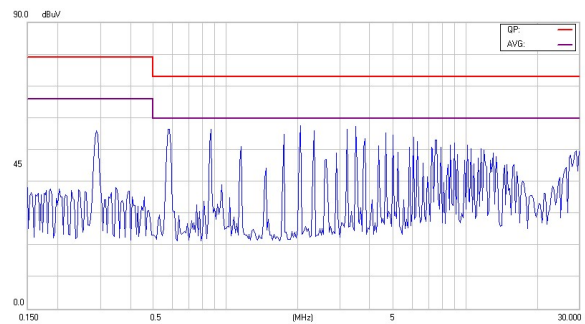

Conducted Class A of CQB150W-24S15
Line

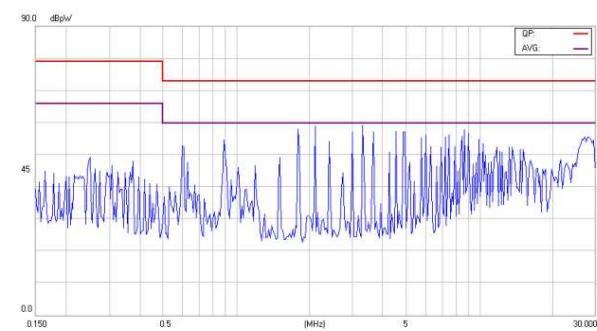

Neutral

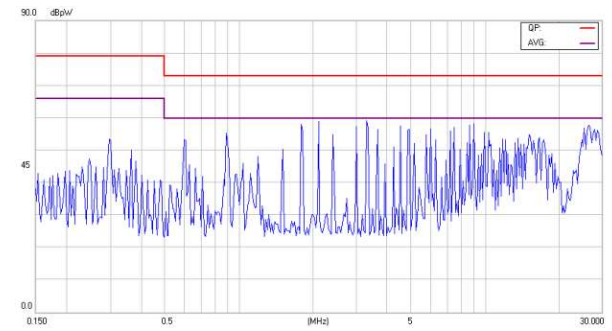



CQB150W-24(48)SXX Series Application Note V15

Conducted Class A of CQB150W-24S24

Line

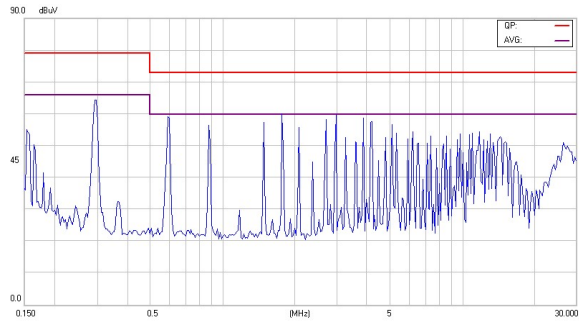

Neutral

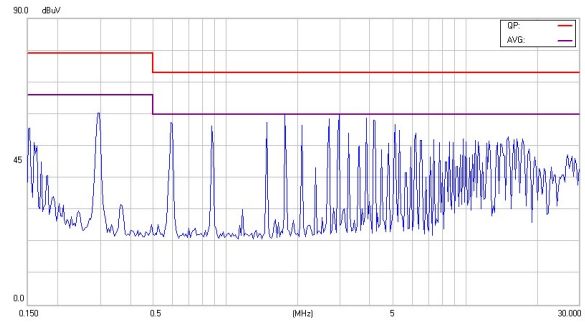

Conducted Class A of CQB150W-24S28

Line

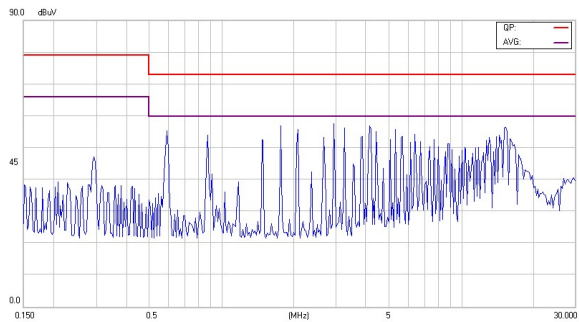

Neutral

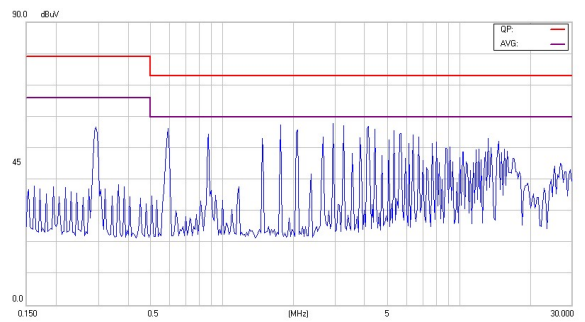

Conducted Class A of CQB150W-24S48

Line

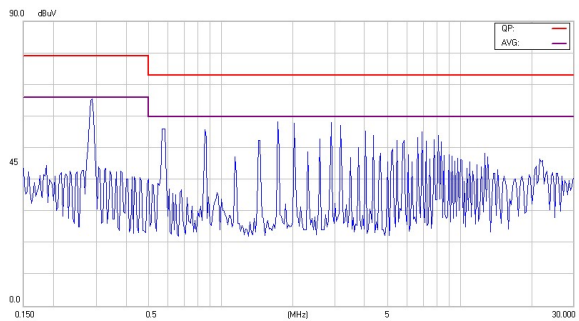

Neutral

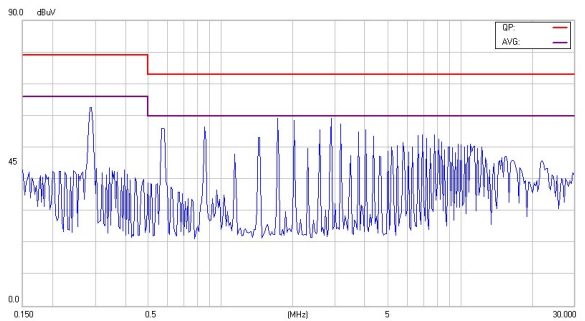

Conducted Class A of CQB150W-48S05

Line

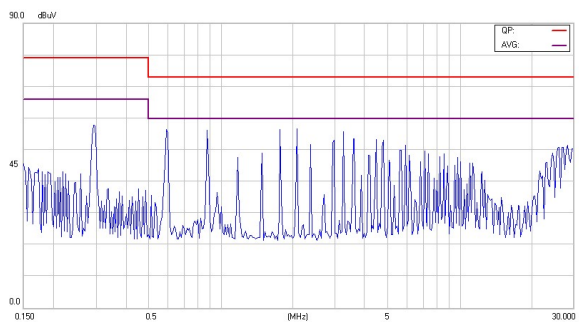

Neutral

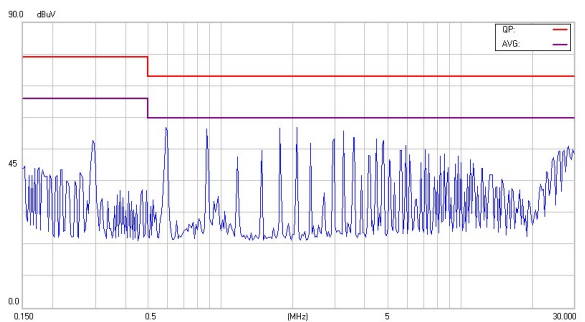



CQB150W-24(48)SXX Series Application Note V15

Conducted Class A of CQB150W-48S12

Line

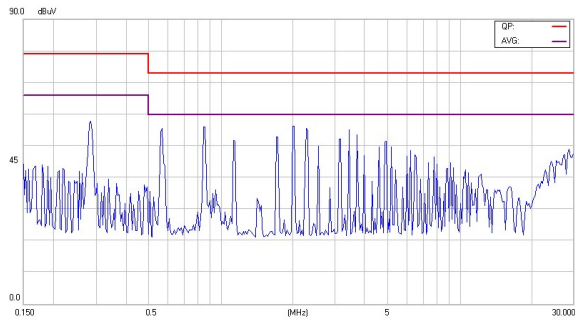

Neutral

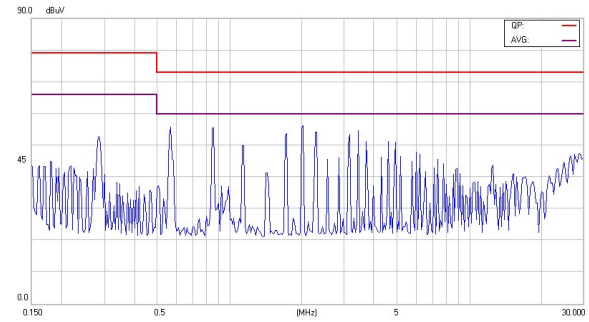

Conducted Class A of CQB150W-48S15

Line

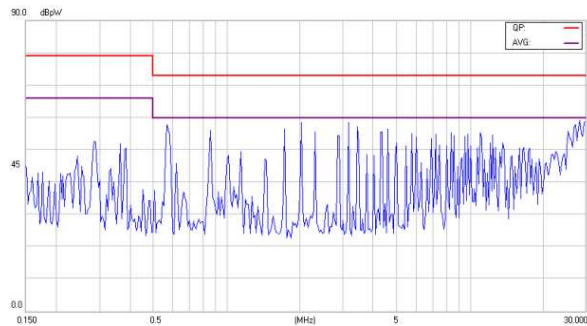

Neutral

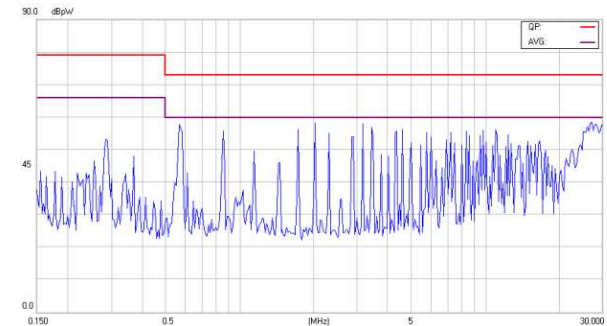

Conducted Class A of CQB150W-48S24

Line

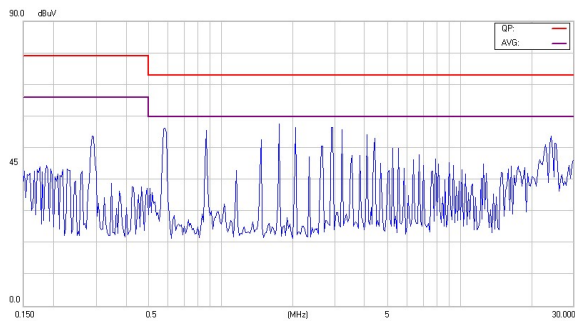

Neutral

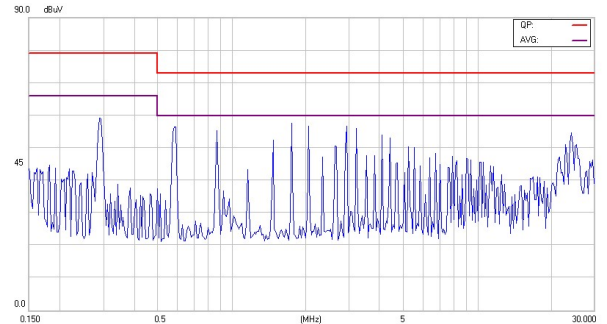

Conducted Class A of CQB150W-48S28

Line

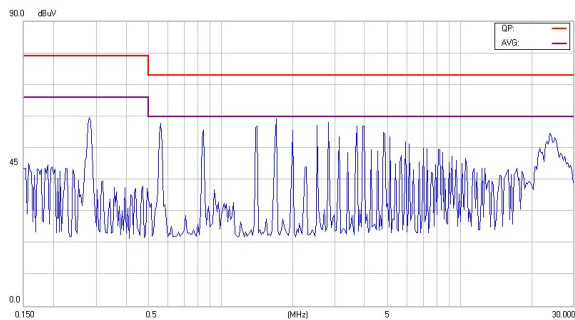

Neutral

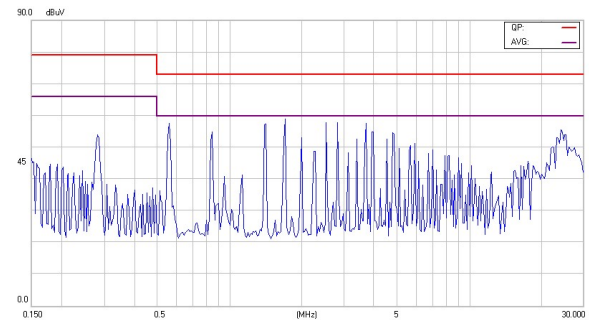



CQB150W-24(48)SXX Series Application Note V15

Conducted Class A of CQB150W-48S48

Line

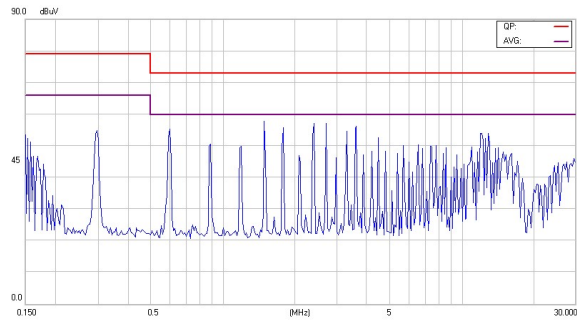

Neutral

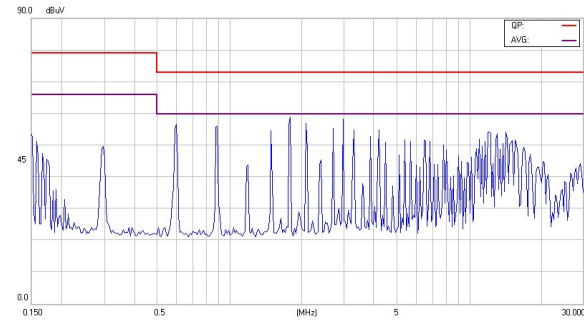

Headquarters:

14F, No.306, Sec.4, Hsin Yi Rd.
Taipei, Taiwan
Tel: 886-2-27086210
Fax: 886-2-27029852
E-mail: sales@cincon.com.tw
Web Site: <https://www.cincon.com>

CINCON ELECTRONICS CO., LTD.

Factory:

No. 8-1, Fu Kung Rd.
Fu Hsing Industrial Park
Fu Hsing Hsiang,
ChangHua Hsien, Taiwan
Tel: 886-4-7690261
Fax: 886-4-7698031

Cincon North America:

1655Mesa Verde Ave. Ste 180
Ventura, CA93003
Tel: 805-639-3350
Fax: 805-639-4101
E-mail: info@cincon.com