



ECB40W18 SERIES 40 WATT 18:1 INPUT ISOLATED DC-DC CONVERTER

Features

- Efficiency up to 90%
- Fixed Switching Frequency
- Regulated Outputs
- Remote On/Off
- Low No Load Power Consumption
- Fully Protected (OTP/OCP/OVP/UVLO)
- 3000Vac I/O Isolation
- Operating Case Temperature -40 to +105°C
- 2"x1"x0.5" Size Meet Industrial Standard
- CB Test Certificate IEC 62368-1 2nd + 3rd
- EN 55032/EN 55035/EN 50155 Compliant with External Circuits
- UL 62368-1 3rd (Reinforced Insulation) Approval (Except 48Vout)
- Shock & Vibration EN 50155 (EN 61373) Compliant
- Fire & Smoke EN 45545-2 Compliant
- 5000m Operating Altitude
- Option Model with Bus Function



MODEL NUMBER	INPUT VOLTAGE	OUTPUT VOLTAGE	OUTPUT CURRENT		INPUT CURRENT		% EFF.		CAPACITOR LOAD MAX.
			MIN.	MAX.	NO LOAD	FULL LOAD	(1)	(2)	
ECB40W18-72S05	8.5-160 VDC	5 VDC	0 mA	8000 mA	10 mA	628 mA	88.5	87.5	25600uF
ECB40W18-72S12	8.5-160 VDC	12 VDC	0 mA	3333 mA	10 mA	617 mA	90	88	5600uF
ECB40W18-72S15	8.5-160 VDC	15 VDC	0 mA	2666 mA	10 mA	628 mA	88.5	87.5	3300uF
ECB40W18-72S24	8.5-160 VDC	24 VDC	0 mA	1666 mA	10 mA	624 mA	89	87.5	1500µF
ECB40W18-72S48	8.5-160 VDC	48 VDC	0 mA	833 mA	10 mA	624 mA	89	88	470µF
ECB40W18-72S54	8.5-160 VDC	54 VDC	0 mA	740 mA	10 mA	624 mA	89	88	440µF

NOTE:

1. Nominal Input Voltage 72 VDC
2. Measured at 110Vin
3. To meet EN50155 and RIA12 refer to application note.

PART NUMBER

Series	Nominal Input Voltage	Number of Outputs	Nominal Output Voltage	Remote On/Off Logic	Option
ECB40W18-	II	O	XX	L	-Y
ECB40W18	72 : 72 VDC	S : Single	05 : 5.0VDC 12 : 12VDC 15 : 15VDC 24 : 24VDC 48 : 48VDC 54 : 54VDC	None : Positive N : Negative	None : Blank -B : With Bus Function

Part Number Example:

ECB40W18-72S12N-B: 2"x1", 40W, 18:1 8.5-160Vdc Input, Single 12Vdc Output, Negative Logic, With Bus Function



ECB40W18 Series

TECHNICAL SPECIFICATIONS

(All specifications are typical at nominal input, full load at 25°C unless otherwise noted.)

ABSOLUTE MAXIMUM RATINGS

PARAMETER	NOTES and CONDITIONS	Device	Min.	Typ.	Max.	Units
Input Voltage	Continuous	All	-0.3		160	V _{dc}
Input Surge Voltage	100ms max.	All			200	V _{dc}
Operating Case Temperature	At the center part of base plate (with derating)	All	-40		105	°C
Storage Temperature		All	-55		125	°C

INPUT CHARACTERISTICS

PARAMETER	NOTES and CONDITIONS	Device	Min.	Typ.	Max.	Units	
Operating Input Voltage		All	8.5	72	160	V _{dc}	
Input Under Voltage Lockout							
Turn-On Voltage Threshold	70% Load	All	7.9	8.5	9.0	V _{dc}	
Turn-Off Voltage Threshold	70% Load	All	6.6	7.2	7.7	V _{dc}	
Lockout Hysteresis Voltage	70% Load	All		1.3		V _{dc}	
Maximum Input Current	V _{in} =12V, Full load V _{in} =8.5V, 70% Load	All			4.4	A	
No-Load Input Current	V _{in} =72V, I _o =0A	See Model Number Table					mA
Input Filter	LC filter	All					
Inrush Current (I ² t)	As per ETS300 132-2	All			0.1	A ² s	
Input Reflected Ripple Current	P-P thru 12uH inductor, 5Hz to 20MHz	All		30		mA	

OUTPUT CHARACTERISTICS

PARAMETER	NOTES and CONDITIONS	Device	Min.	Typ.	Max.	Units
Voltage Set Point Accuracy	V _{in} =72V, Full load, T _c =25°C	All	-1.0		+1.0	%
Output Voltage Regulation						
Load Regulation	Full load to no load	All			±0.5	%
Line Regulation	V _{in} =High line to low line, full load	All			±0.2	%
Temperature Coefficient	T _c =-40°C to 105°C	All			±0.02	%/°C
Output Voltage Ripple and Noise (5Hz to 20MHz bandwidth)						
Peak-to-Peak	Full load, 1.0uF ceramic capacitors	5Vo			100	mV
		12Vo			150	
		15Vo			150	
		24Vo			240	
		48Vo			480	
		54Vo			540	
RMS.		5Vo			40	mV
		12Vo			60	
		15Vo			60	
		24Vo			100	
		48Vo			200	
		54Vo			220	
Output Current Range	V _{in} = 8.5 to 12V	See Power Derating Curve				A
	V _{in} = 12 to 160V	See Model Number Table				
Over Current Protection	Hiccup mode. Auto recovery	All	110	150	190	%
Short Circuit Protection		All	Continuous, Auto Recovery			
External Load Capacitance	Full load (resistive)	See Model Number Table				uF



ECB40W18 Series

PARAMETER	NOTES and CONDITIONS	Device	Min.	Typ.	Max.	Units
Output Voltage Trim Range	$P_o \leq \text{max. rated power}$, $I_o \leq I_{o_max}$.	48&54Vo Others	-20 -20		+10 +15	%
Over Voltage Protection	Zener or TVS clamp	5Vo 12Vo 15Vo 24Vo 48Vo 54Vo		6.2 15 18 30 56.1 70.2		V _{dc}
Bus Pin Output Voltage	$V_{in} = 24$ to $160V$, $T_c = 25^\circ C$	-B Only		26	30	V _{dc}

EFFICIENCY

PARAMETER	NOTES and CONDITIONS	Device	Min.	Typ.	Max.	Units
100% Load	$V_{in} = 72V$, $110V$		See Model Number Table			%

DYNAMIC CHARACTERISTICS

PARAMETER	NOTES and CONDITIONS	Device	Min.	Typ.	Max.	Units
Output Voltage Current Transient						
Error Band	75% to 100% of I_{o_max} . step load change $dI/dt = 0.1A/us$	All			±5	%
Recovery Time	(within 1% V_{out} nominal)	All		250	350	us
Turn-On Delay and Rise Time	Full load (Constant resistive load)					
Turn-On Delay Time, From On/Off Control	$V_{on/off}$ to 10% V_{o_set} , Remote on	All		5		ms
Turn-On Delay Time, From Input	V_{in_min} . to 10% V_{o_set} , Power up	All		5		ms
Output Voltage Rise Time	10% V_{o_set} to 90% V_{o_set}	All		10		ms

ISOLATION CHARACTERISTICS

PARAMETER	NOTES and CONDITIONS	Device	Min.	Typ.	Max.	Units
Isolation Voltage (100% Factory Hi-Pot Tested @2sec.)	1 Minute; input to output	All			3000 4200	V _{ac} V _{dc}
	1 Minute; input to case (base plate)				2100 3000	V _{ac} V _{dc}
	1 Minute; output to case (base plate)				1500 2100	V _{ac} V _{dc}
Isolation Resistance	Input to output	All	1000			MΩ
Isolation Capacitance	Input to output (10KHz, 0.25V)	All		700		pF
	Input to case (base plate)			None		
	Output to case (base plate)			None		

FEATURE CHARACTERISTICS

PARAMETER	NOTES and CONDITIONS	Device	Min.	Typ.	Max.	Units
Switching Frequency	Output ripple frequency	5Vo 12Vo	180	200	220	KHz
		15Vo 24Vo 48Vo 54Vo	207	230	253	
On/Off Control, Positive Remote On/Off Logic, Refer to -Vin Pin						
Logic Low (Module Off)	$V_{on/off}$ at $I_{on/off} = 1.0mA$	All	0		1.2	V
Logic High (Module On)	$V_{on/off}$ at $I_{on/off} = 0.0uA$, Pin open=On	All	3.5 or Open Circuit		160	V



ECB40W18 Series

PARAMETER	NOTES and CONDITIONS	Device	Min.	Typ.	Max.	Units
On/Off Control, Negative Remote On/Off Logic, Refer to -Vin Pin						
Logic High (Module Off)	$V_{on/off}$ at $I_{on/off}=0.0\mu A$, Pin open=Off	All	3.5 or Open Circuit		160	V
Logic Low (Module On)	$V_{on/off}$ at $I_{on/off}=1.0mA$	All	0		1.2	V
On/Off Current (for Both Remote On/Off Logic)	$I_{on/off}$ at $V_{on/off}=0V$	All		0.4	1	mA
Leakage Current (for Both Remote On/Off Logic)	Logic high, $V_{on/off}=15V$	All			30	μA
Off Converter Input Current	Shutdown input idle current	All		3	5	mA
Over Temperature Shutdown	Temperature at the center part of case, non-latching	All		110		$^{\circ}C$
Over Temperature Recovery		All		92		$^{\circ}C$

GENERAL SPECIFICATIONS

PARAMETER	NOTES and CONDITIONS	Device	Min.	Typ.	Max.	Units
MTBF	$I_o=100\%$ of $I_{o,max}$; MIL-HDBK - 217F_Notice 1, GB, 25 $^{\circ}C$	5Vo		2013		K hours
		12Vo		1912		
		15Vo		2321		
		24Vo		2190		
		48Vo		2600		
		54Vo		2386		
		5Vo-B		1840		
		12Vo-B		1756		
		15Vo-B		2094		
		24Vo-B		1987		
Weight		5Vo		40		grams
		12Vo				
		others		35		
Case Material	Plastic, DAP, UL 94V-0					
Base plate Material	Aluminum					
Potting Material	UL 94V-0					
Pin Material	Base: Copper Plating: Nickel with Matte Tin					
Shock/Vibration	MIL-STD-810F/EN 61373 Compliant					
Humidity	95% RH max. Non Condensing					
Altitude	5000m Operating Altitude, 12000m Transport Altitude					
Thermal Shock	MIL-STD-810F					
Fire & Smoke	EN 45545-2 Compliant					

EMC SPECIFICATIONS (External components required, please refer to application note.)

EMI	EN 55032 & EN 50155 Compliant (with external filter)				Class A
ESD	EN 61000-4-2	Level 3: Air $\pm 8kV$, Contact $\pm 6kV$			Perf. Criteria A
Radiated Immunity	EN 61000-4-3	Level 3: 80~1000MHz, 20V/m			Perf. Criteria A
Fast Transient	EN 61000-4-4	Level 3: On power input port, $\pm 2kV$, external components required			Perf. Criteria A
Surge	EN 61000-4-5	Level 4: Line to earth, $\pm 4kV$, Line to line, $\pm 2kV$ (EN 50155) Level 3: Line to earth, $\pm 2kV$, Line to line, $\pm 1kV$ (EN 55035), external components required			Perf. Criteria A
Conducted Immunity	EN 61000-4-6	Level 3: 0.15~80MHz, 10V			Perf. Criteria A
Magnetic field immunity	EN 61000-4-8	Level 1: 50Hz, 1A/m (EN 55035)			Perf. Criteria A
Interruptions of Voltage Supply	EN 50155	Class S3: 20ms interruptions, external hold up circuit and capacitor required			Perf. Criteria A



ECB40W18 Series

GENERAL SPECIFICATIONS

Supply Change Over	EN 50155	Class C2: During a supply break of 30ms, external hold up circuit and capacitor required	Perf. Criteria A
Application Note Link	ECB40W18-72S Series App Notes		
Packaging Information Link	Packaging Information		

Immunity to Environmental Conditions

Phenomenon	EN 50155:2021 Reference Clause(s)	Reference Standard	Test Conditions	Result
Low Temperature Test	13.4.4	EN 60068-2-1	Class OT4 Temperature: -40°C Duration: 2 hrs	Pass
Dry Heat Test	13.4.5	EN 60068-2-2	Class OT4 & Cycle A Temperature: 70°C Duration: 6 hrs	Pass
Low Temperature Storage Test	13.4.6	EN 60068-2-1	Temperature: -40°C Duration: 16 hrs	Pass
Cyclic Damp Heat Test	13.4.8	EN 60068-2-30	Temperature: 25°C - 55°C Humidity: 90% RH Duration: 48 hrs	Pass
Functional Random Vibration Test	13.4.10	EN 61373	Frequency range: 5 ~ 150 Hz Vertical: 1.01 m/s^2 Transverse: 0.450 m/s^2 Longitudinal: 0.700 m/s^2 Duration: 10 min / axis	Pass
Simulated Long Life Test at Increased Random Vibration Levels	13.4.10	EN 61373	Frequency range: 5 ~ 150 Hz Vertical: 5.72 m/s^2 Transverse: 2.55 m/s^2 Longitudinal: 3.96 m/s^2 Duration: 5 hrs / axis	Pass
Shock Test	13.4.10	EN 61373	±Vertical: 30 m/s^2 ±Transverse: 30 m/s^2 ±Longitudinal: 50 m/s^2 Duration: 30ms x18 (Each axis 3 shocks)	Pass

EN45545-2 Fire & Smoke Test Conditions

Item	Standard	Hazard Level
R22	Oxygen Index Test EN 45545-2: 2013+A1:2015 EN ISO 4589-2: 2017	HL1, HL2, HL3
	Smoke Density Test EN 45545-2: 2013+A1:2015 EN ISO 5659-2: 2017	HL1, HL2, HL3
	Smoke Toxicity Test EN 45545-2: 2013+A1:2015 NF X70-100-1&2: 2006	HL1, HL2, HL3
R23	Oxygen Index Test EN 45545-2: 2013+A1:2015 EN ISO 4589-2: 2017	HL1, HL2, HL3
	Smoke Density Test EN 45545-2: 2013+A1:2015 EN ISO 5659-2: 2017	HL1, HL2, HL3
	Smoke Toxicity Test EN 45545-2: 2013+A1:2015 NF X70-100-1&2: 2006	HL1, HL2, HL3
R24	Oxygen Index Test EN 45545-2: 2013 EN ISO 4589-2	HL1, HL2, HL3
R25	Glow - Wire Test EN 45545-2:2013+A1:2016 EN 60695-2-11:2014	HL1, HL2, HL3
R26	Vertical Flame Test EN 45545-2: 2013+A1:2015 EN 60695-11-10: 2013	HL1, HL2, HL3



ECB40W18 Series

CHARACTERISTIC CURVE

Power Derating Curve

ECB40W18-72S05/15 Derating Curve without Heatsink (Vin=72V)

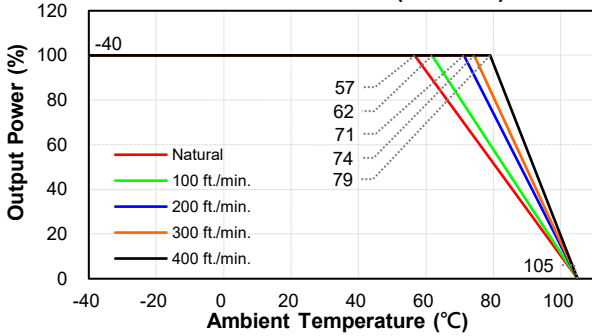

ECB40W18-72S05/15 Derating Curve with Heatsink BL150G (Vin=72V)

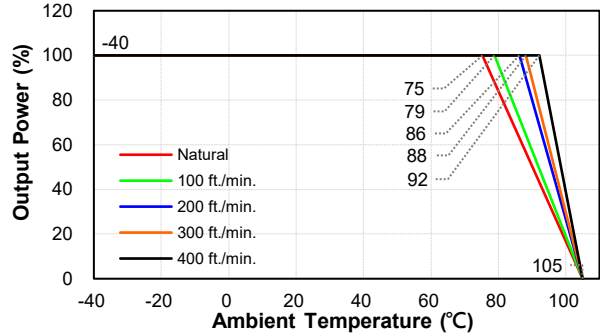

ECB40W18-72S12 Derating Curve without Heatsink (Vin=72V)

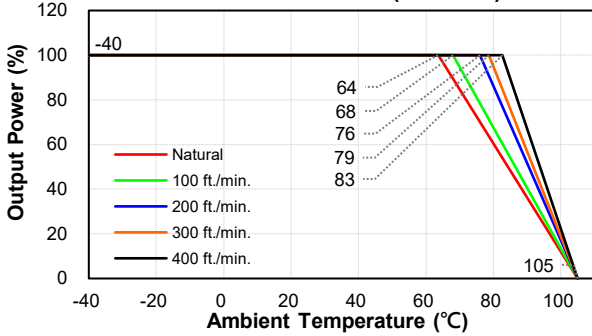

ECB40W18-72S12 Derating Curve with Heatsink BL150G (Vin=72V)

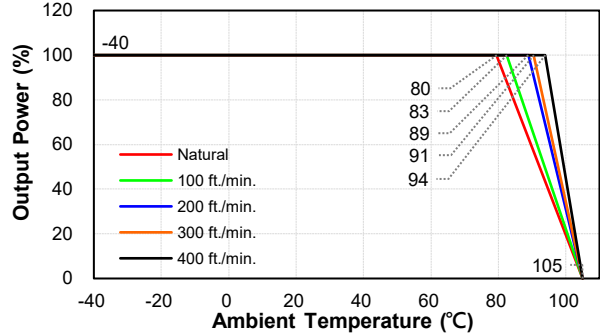

ECB40W18-72S24/48/54 Derating Curve without Heatsink (Vin=72V)

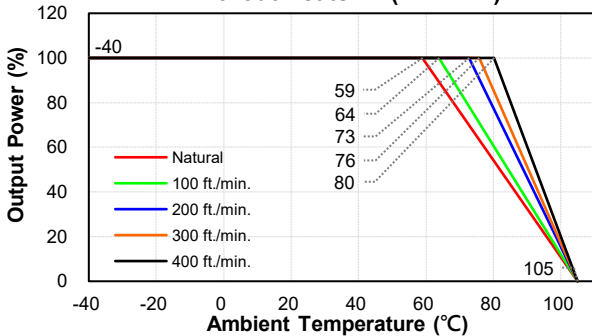

ECB40W18-72S24/48/54 Derating Curve with Heatsink BL150G (Vin=72V)

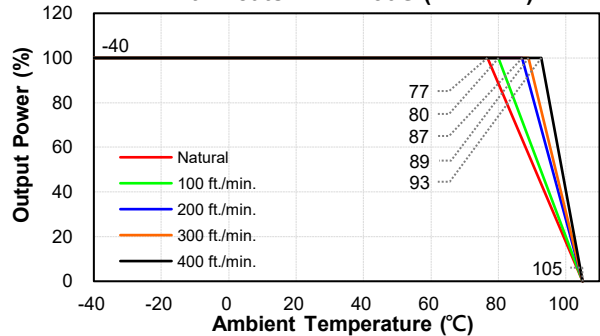



ECB40W18 Series

**ECB40W18-72 Input Voltage
Derating Curve**

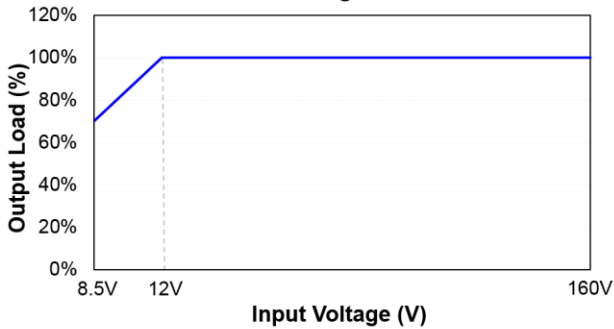

Performance Data

**ECB40W18-72S05
Eff Vs Io @25 Deg. C**

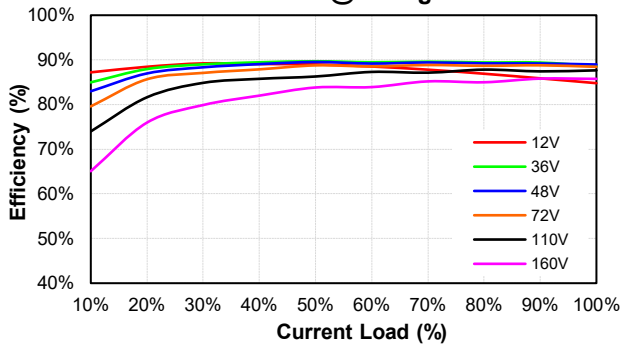

**ECB40W18-72S05
Pd Vs Po @25 Deg. C**

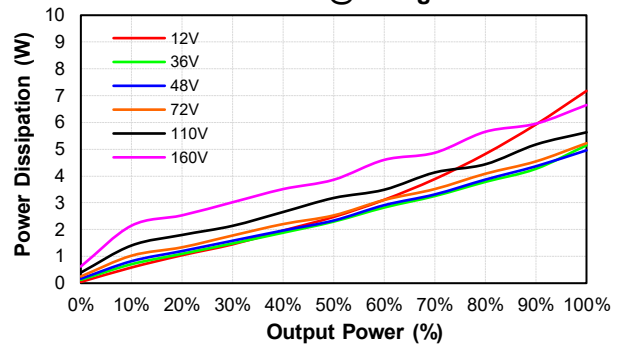

**ECB40W18-72S12
Eff Vs Io @25 Deg. C**

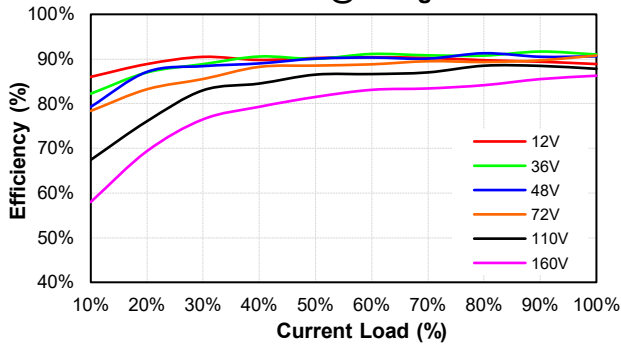

**ECB40W18-72S12
Pd Vs Po @25 Deg. C**

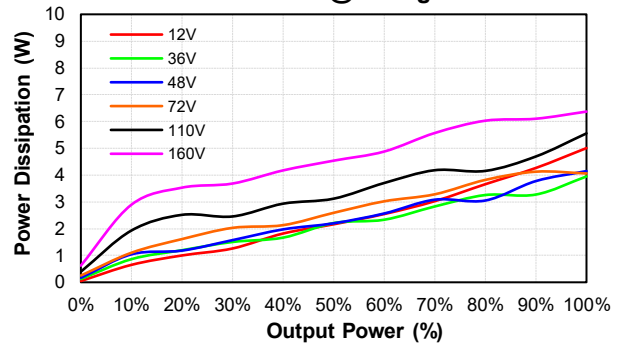

**ECB40W18-72S15
Eff Vs Io @25 Deg. C**

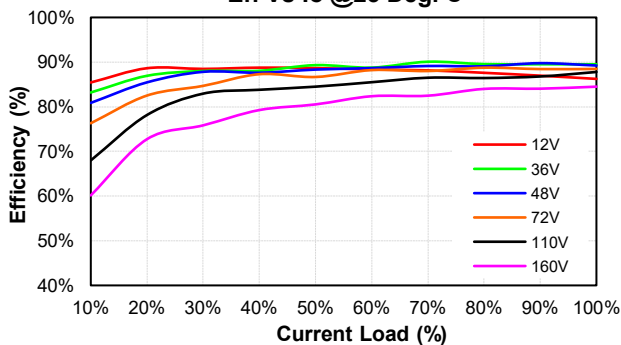

**ECB40W18-72S15
Pd Vs Po @25 Deg. C**

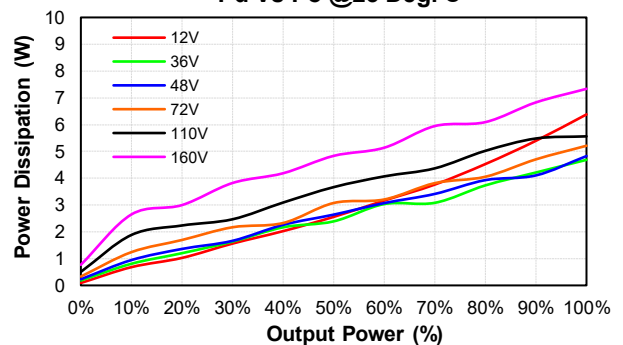



ECB40W18 Series

ECB40W18-72S24
Eff Vs Io @25 Deg. C

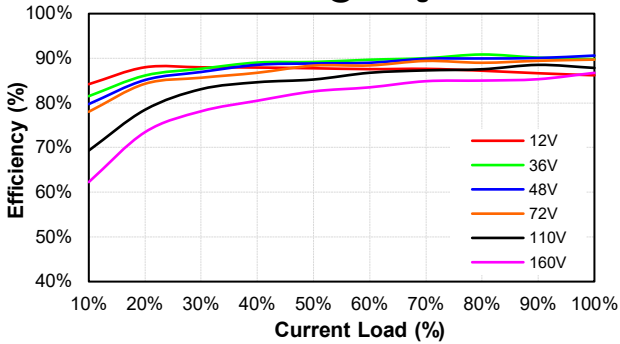

ECB40W18-72S24
Pd Vs Po @25 Deg. C

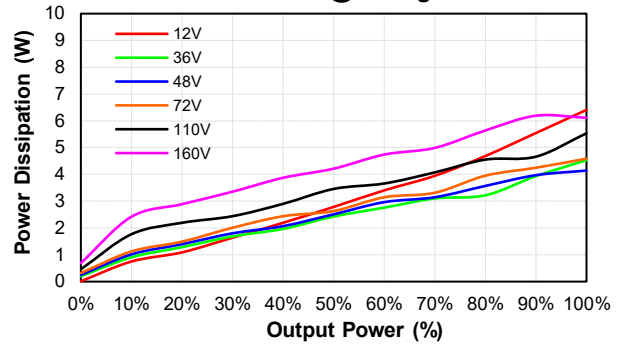

ECB40W18-72S48
Eff Vs Io @25 Deg. C

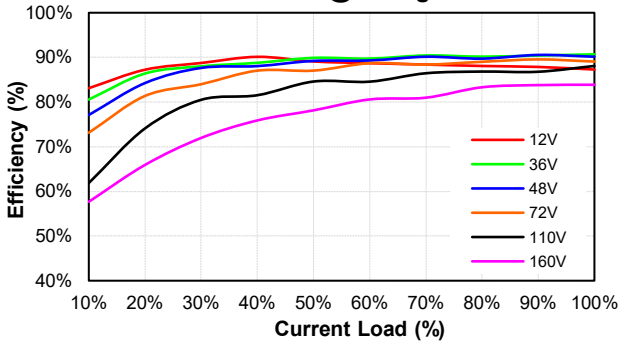

ECB40W18-72S48
Pd Vs Po @25 Deg. C

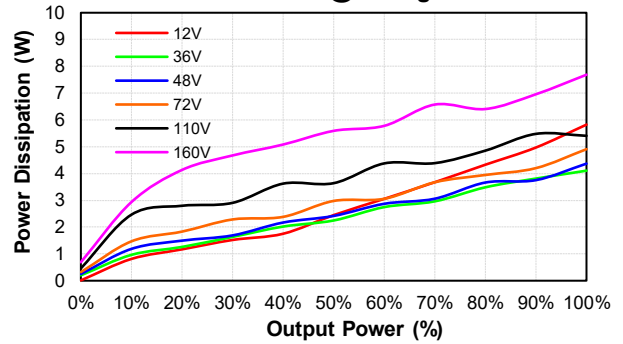

ECB40W18-72S54
Eff Vs Io @25 Deg. C

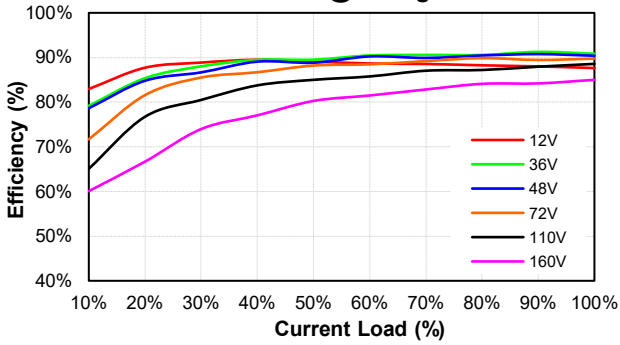

ECB40W18-72S54
Pd Vs Po @25 Deg. C

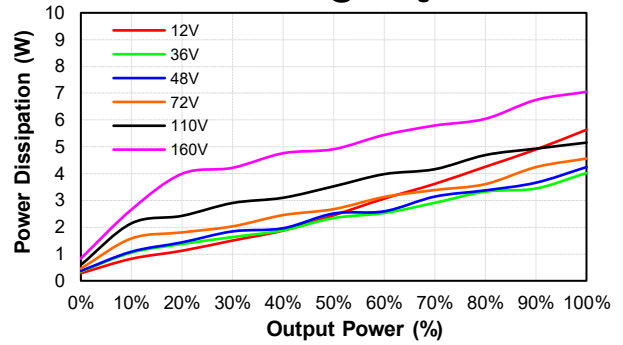

ECB40W18-72S05
Eff Vs Vin @25 Deg. C

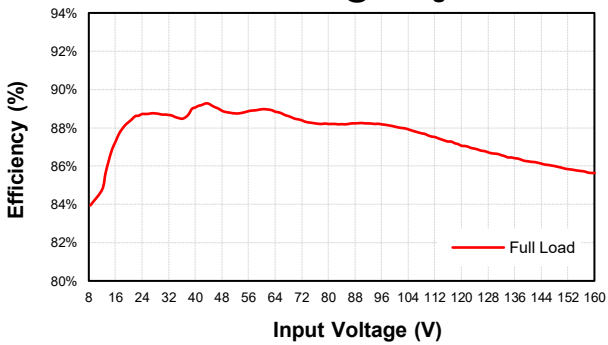

ECB40W18-72S12
Eff Vs Vin @25 Deg. C

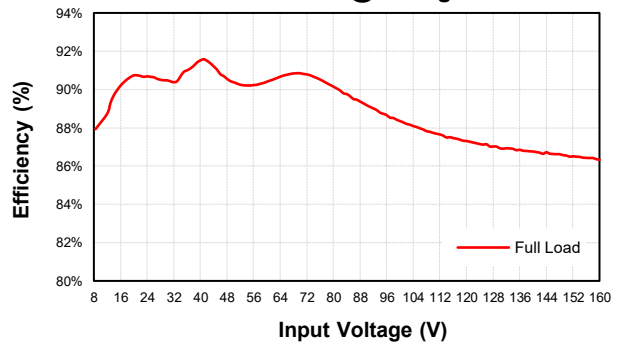



ECB40W18 Series

ECB40W18-72S15
Eff Vs Vin @25 Deg. C

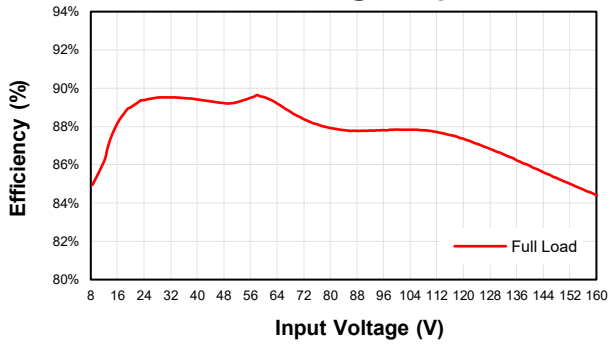

ECB40W18-72S24
Eff Vs Vin @25 Deg. C

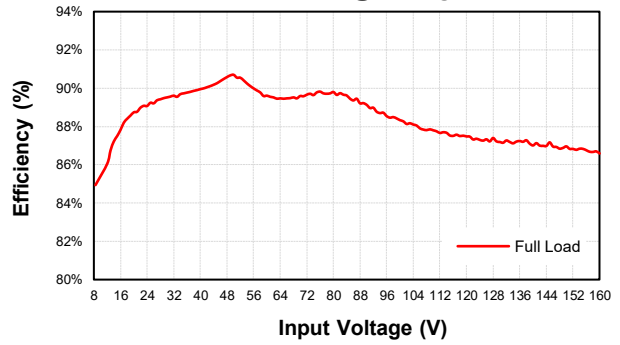

ECB40W18-72S48
Eff Vs Vin @25 Deg. C

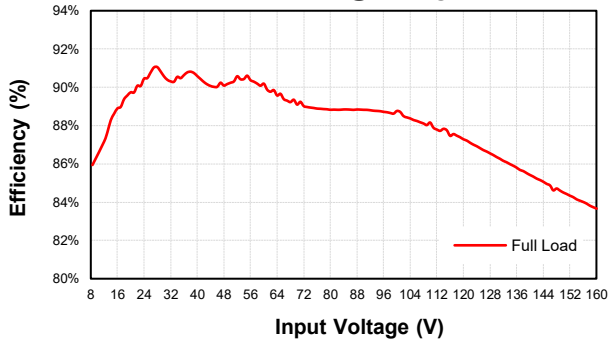

ECB40W18-72S54
Eff Vs Vin @25 Deg. C

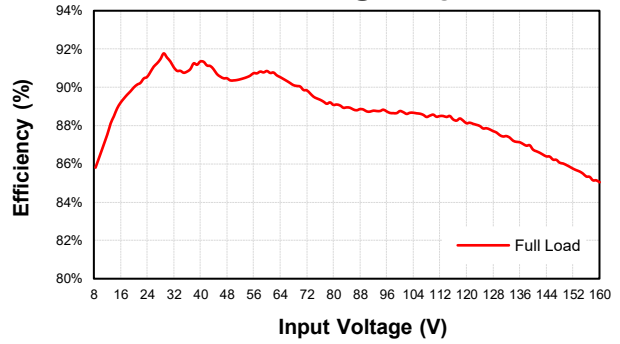

Note: 8.5Vin Efficiency at 70% Full Load



ECB40W18 Series

MECHANICAL SPECIFICATION

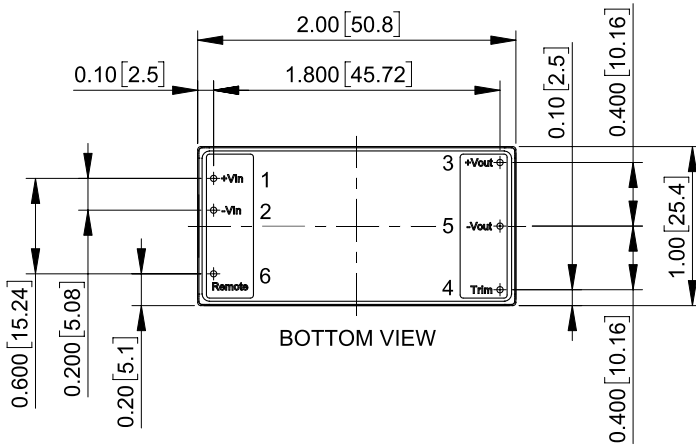

All Dimensions in Inches[mm]
 Tolerance Inches: x.xx=±0.02, x.xxx=±0.010
 Millimeters: x.x=±0.5, x.xx=±0.25

Pin Connection

Pin	Function
1	+V Input
2	-V Input
3	+V Output
4	Trim
5	-V Output
6	Remote On/Off

Note: Pin Size is $\phi 0.04 \pm 0.004$ Inch [$\phi 1.0 \pm 0.1$ mm]

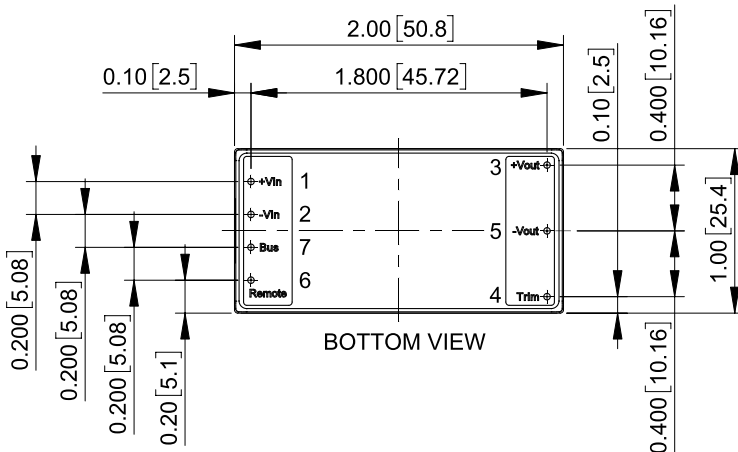
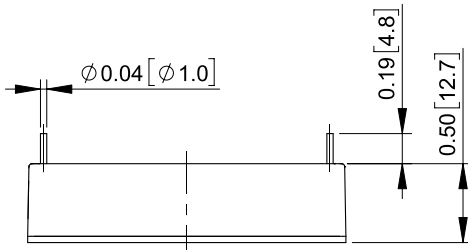

Option: with Bus Function

All Dimensions in Inches[mm]
 Tolerance Inches: x.xx=±0.02, x.xxx=±0.010
 Millimeters: x.x=±0.5, x.xx=±0.25

Pin Connection

Pin	Function
1	+V Input
2	-V Input
3	+V Output
4	Trim
5	-V Output
6	Remote On/Off
7	Bus

Note: Pin Size is $\phi 0.04 \pm 0.004$ Inch [$\phi 1.0 \pm 0.1$ mm]

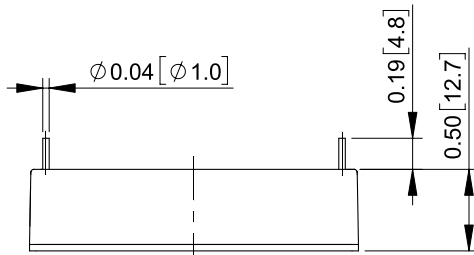

CINCON Electronics Co. Ltd.
 Add: 14F, No. 306, Sec.4, Hsin Yi Rd., Taipei, Taiwan
 Tel: 886-2-27086210
 Fax: 886-2-27029852
 E-mail: sales@cincon.com
 Web: www.cincon.com