



EC6AW Series Application Note V13

ISOLATED DC-DC CONVERTER EC6AW SERIES APPLICATION NOTE



Approved By:

Department	Approved By	Checked By	Written By
Research and Development Department	Jacky	Danny/Johnny	Joyce
Design Quality Department	Benny	JoJo	



EC6AW Series Application Note V13

Contents

1. Introduction	3
2. Pin Function Description	3
3. Connection for Standard Use	4
4. Test Set-Up	4
5. Recommend Layout, PCB Footprint and Soldering Information.....	4
6. Features and Functions	6
6.1 UVLO (Under Voltage Lock Out)	6
6.2 Over Current/Short Circuit Protection	6
6.3 Output Over Voltage Protection	6
6.4 Remote On/Off	6
7. Input / Output Considerations	7
7.1 Input Capacitance at the Power Module	7
7.2 Output Ripple and Noise	7
7.3 Output Capacitance	7
8. Thermal Design.....	8
8.1 Operating Temperature Range	8
8.2 Convection Requirements for Cooling	8
8.3 Thermal Considerations	8
8.4 Power Derating	8
9. Safety & EMC	9
9.1 Input Fusing and Safety Considerations	9
9.2 EMC Considerations	9



EC6AW Series

Application Note V13

1. Introduction

The EC6AW with industry standard DIP-24 dimension 1.25 x 0.80 x 0.4 inches and SMD 1.25 x 0.80 x 0.43 inches and EC6AW series provide 8W of output power @ single output voltages of 3.3, 5, 12, 15VDC and dual outputs voltages of ± 5 , ± 12 , ± 15 VDC. It has a wide (4:1) input voltage range of 9-36VDC (24VDC nominal) and 18-75VDC (24, 48VDC nominal) and 1500VDC isolation.

EC6AW is designed to comply with the EN50155 standard (with external filters) and meet shock and vibration requirements. EC6AW is also designed to operate in harsh environments, the potted and encapsulated design provides increased system reliability through added protection from environmental factors such as dust and moisture. Additionally, all models carry CE mark and meet EN 45545 railway fire & smoke standard. The EC6AW series have a very high efficiency up to 86% and allows ambient operating temperature range of -40°C to 85°C (de-rating above 71°C).

EC6AW series also feature very low no load power consumption (10mA) and make these converters an ideal solution for energy critical systems. Furthermore, the remote on/off (positive or negative) is provided.

The modules are fully protected against input UVLO (under voltage lock out), output over-current, output over-voltage and continuous short circuit conditions.

EC6AW is designed primarily for suitable for distributed power architectures, telecommunications, battery operated equipment and industrial applications.

2. Pin Function Description

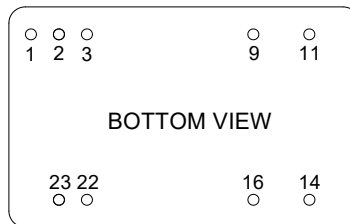

Single Output

No	Label	Function	Description	Reference
1	R	Remote On/Off	External Remote On/Off Control	Section 6.4
2 & 3	-IN	-V Input	Negative Supply Input	Section 7.1
9	--	NP	No Pin	--
11	--	NC	No Connection with Pin	--
14	+OUT	+V Output	Positive Power Output	Section 7.2/7.3
16	-OUT	-V Output	Negative Power Output	Section 7.2/7.3
22 & 23	+IN	+V Input	Positive Supply Input	Section 7.1

Dual Output

No	Label	Function	Description	Reference
1	R	Remote On/Off	External Remote On/Off Control	Section 6.4
2 & 3	-IN	-V Input	Negative Supply Input	Section 7.1
9 & 16	+V2, -V1	Common	Common Power Output	Section 7.2/7.3
11	-V2	-V Output	Negative Power Output	Section 7.2/7.3
14	+V1	+V Output	Positive Power Output	Section 7.2/7.3
22 & 23	+IN	+V Input	Positive Supply Input	Section 7.1



EC6AW Series Application Note V13

3. Connection for Standard Use

The connection for standard use is shown below. External output capacitors (C1, C2) are recommended to reduce output ripple and noise, 0.1uF ceramic capacitor for all models.

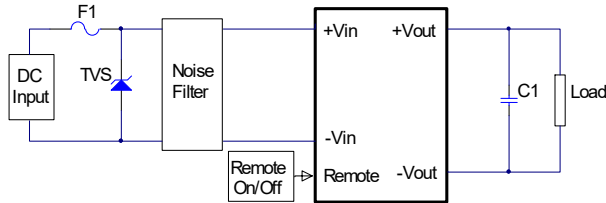

EC6AW single output module

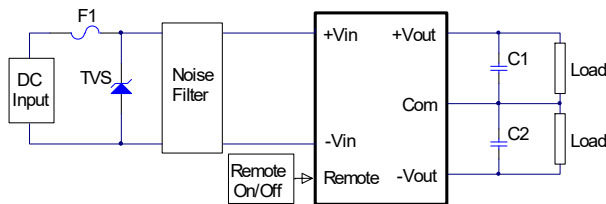

EC6AW dual output module

Symbol	Component	Reference
F1, TVS	Input fuse, TVS	Section 9.1
C1, C2	External capacitor on the output side	Section 7.3
Noise Filter	External input noise filter	Section 9.2
Remote On/Off	External remote on/off control	Section 6.4

4. Test Set-Up

The basic test set-up to measure parameters such as efficiency and load regulation is shown below. When testing the modules under any transient conditions, please ensure that the transient response of the source is sufficient to power the equipment under test. We can calculate:

- Efficiency
- Load regulation and line regulation

The value of efficiency is defined as:

$$\eta = \frac{V_o \times I_o}{V_{in} \times I_{in}} \times 100\%$$

Where:

- V_o is output voltage,
- I_o is output current,
- V_{in} is input voltage,
- I_{in} is input current

The value of load regulation is defined as:

$$Load\ reg. = \frac{V_{FL} - V_{NL}}{V_{NL}} \times 100\%$$

Where:

- V_{FL} is the output voltage at full load
- V_{NL} is the output voltage at 10% load

The value of line regulation is defined as:

$$Line\ reg. = \frac{V_{HL} - V_{LL}}{V_{LL}} \times 100\%$$

Where:

- V_{HL} is the output voltage of maximum input voltage at full load
- V_{LL} is the output voltage of minimum input voltage at full load

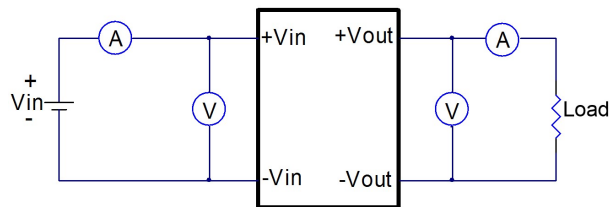

EC6AW Series Test Setup

5. Recommend Layout, PCB Footprint and Soldering Information

The system designer or end user must ensure that metal and other components in the vicinity of the converter meet the spacing requirements for which the system is approved. Low resistance and inductance PCB layout traces are the norm and should be used where possible. Due consideration must also be given to proper low impedance tracks between power module, input and output grounds. The recommended footprints and soldering profiles are shown below.



EC6AW Series Application Note V13

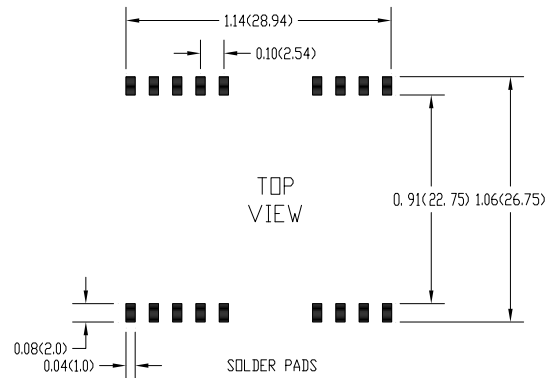
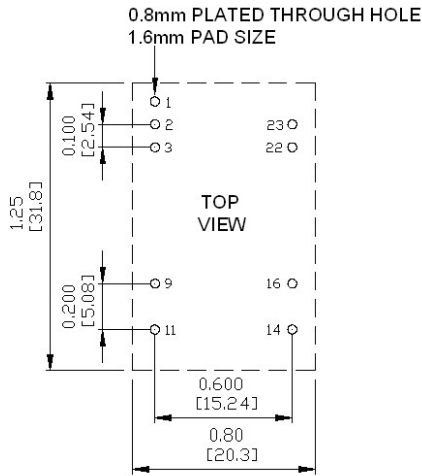

Note: Dimensions are in inches (millimeters)

Clean the soldered side of the module with a brush, prevent liquid from getting into the module. Do not clean by soaking the module into liquid. Do not allow solvent to come in contact with product labels or resin case as this may change the color of the resin case or cause deletion of the letters printed on the product label. After cleaning, dry the modules well.

The suggested soldering iron is $420 \pm 10^\circ\text{C}$ for up to 4-10 seconds (less than 90W) used in double PCB and multilayer PCB, The other one is used in the single PCB is $385 \pm 10^\circ\text{C}$ for up to 2-6 seconds (less than 90W). Furthermore the recommended soldering profile is shown below.

Lead Free Hot Air Reflow Profile

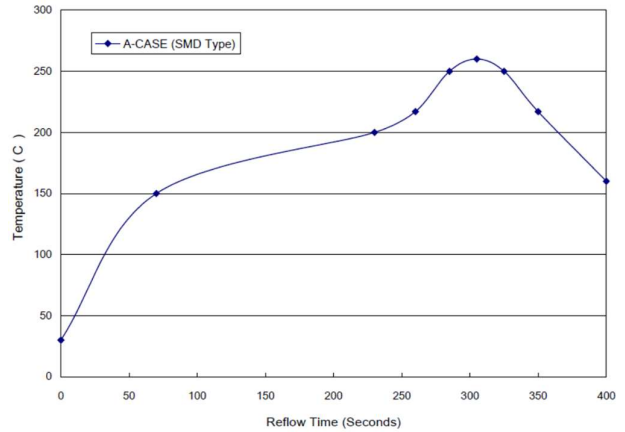

Lead Free Wave Soldering Profile

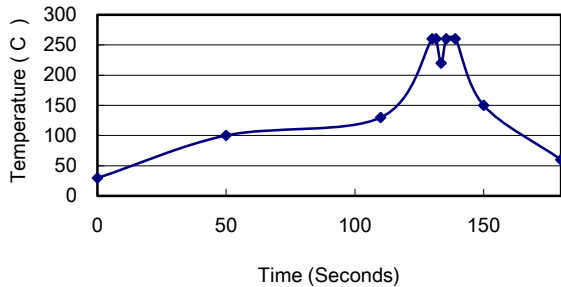

Recommended PCB Layout Footprints and Wave Soldering Profiles for DIP-24 and SMD packages



EC6AW Series Application Note V13

6. Features and Functions

6.1 UVLO (Under Voltage Lock Out)

Input under voltage lockout is standard on the EC6AW series unit. The unit will shut down when the input voltage drops below a lower threshold, and the unit will operate when the input voltage goes above the upper threshold.

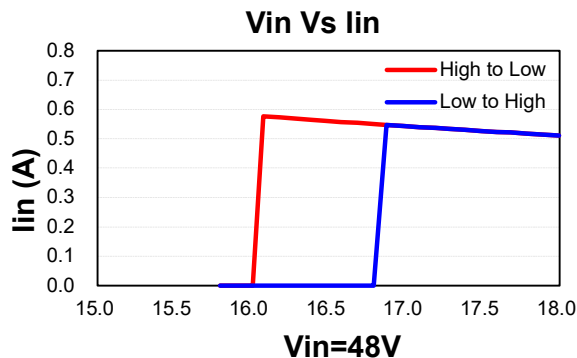
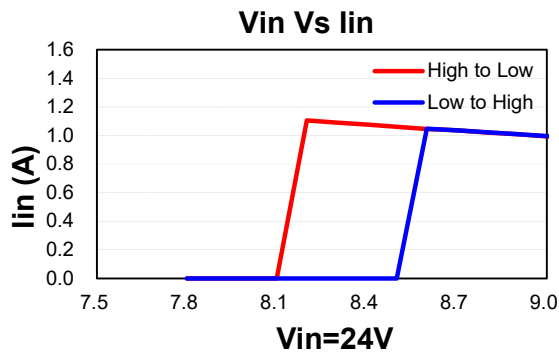

6.2 Over Current/Short Circuit Protection

All different voltage models have full continuous short-circuit protection. To provide protection in a fault condition, the unit is equipped with internal over-current protection. The unit operates normally once the fault condition is removed. At the point of current-limit inception, the converter will go into over current protection.

6.3 Output Over Voltage Protection

The over-voltage protection consists of a zener diode to limiting the out voltage.

6.4 Remote On/Off

The EC6AW series allows the user to switch the module on and off electronically with the remote on/off feature. All models are available in "positive logic" versions. The converter turns on if the remote **on/off** pin is high (>3.5Vdc to 36Vdc or open circuit). Setting the pin low (0 to <1.2Vdc) will turn the converter off. The signal level of the remote **on/off** input is defined with respect to ground.

If not using the remote **on/off** pin, leave the pin open (converter will be on).

Models with part number suffix "N" are the "negative logic" remote **on/off** version. The unit turns off if the remote **on/off** pin is high (>3.5Vdc to 36Vdc or open circuit). The converter turns on if the **on/off** pin input is low (0 to <1.2Vdc). Note that the converter is off by default.

Logic State (Pin 1)	Positive Logic	Negative Logic
Logic Low	Module off	Module on
Logic High	Module on	Module off

The converter remote **on/off** circuit built-in on input side. The ground pin of input side remote **on/off** circuit is -vin pin. Inside connection sees below.

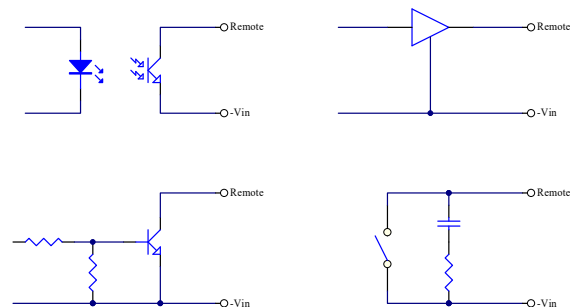

Remote On/Off Connection Examples



EC6AW Series Application Note V13

7. Input / Output Considerations

7.1 Input Capacitance at the Power Module

The converters must be connected to low AC source impedance. To avoid problems with loop stability source inductance should be low. Also, the input capacitors (Cin) should be placed close to the converter input pins to de-couple distribution inductance. However, the external input capacitors are chosen for suitable ripple handling capability. Low ESR capacitors are good choice. Circuit as shown as below represents typical measurement methods for reflected ripple current. C1 and L1 simulate a typical DC source impedance. The input reflected-ripple current is measured by current probe to oscilloscope with a simulated source Inductance (L1).

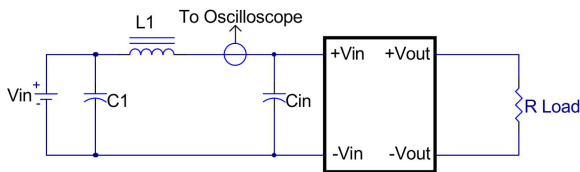

- L1: 1uH
- C1: None
- Cin: 6.8uF ceramic capacitor

7.2 Output Ripple and Noise

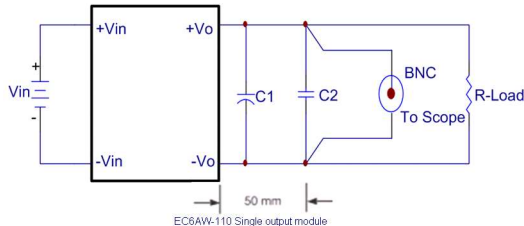

- Note:
- C1: None
 - C2: 0.1uF ceramic capacitor

EC6AW single output module

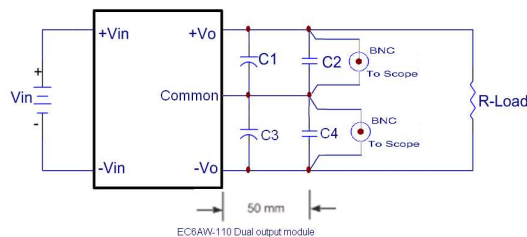

- Note:
- C1 & C3: None
 - C2 & C4: 0.1uF ceramic capacitor

EC6AW dual output module

Output ripple and noise measured with 0.1uF ceramic capacitor across output, A 20 MHz bandwidth oscilloscope is normally used for the measurement.

The conventional ground clip on an oscilloscope probe should never be used in this kind of measurement. This clip, when placed in a field of radiated high frequency energy, acts as an antenna or inductive pickup loop, creating an extraneous voltage that is not part of the output noise of the converter.

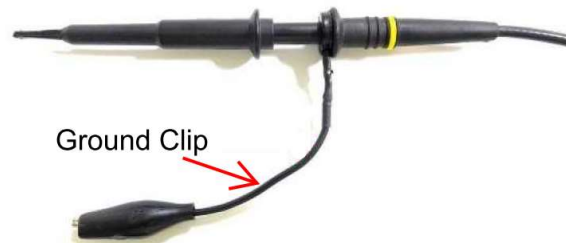

Another method is shown in below, in case of coaxial-cable/BNC is not available. The noise pickup is eliminated by pressing scope probe ground ring directly against the -Vout terminal while the tip contacts the +Vout terminal. This makes the shortest possible connection across the output terminals.

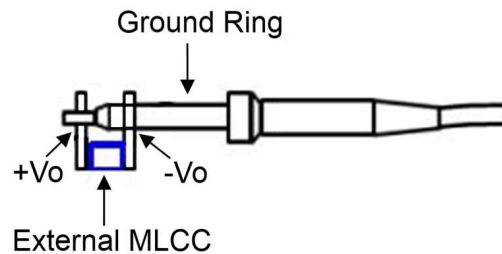

7.3 Output Capacitance

The EC6AW series converters provide unconditional stability with or without external capacitors. For good transient response, low ESR output capacitors should be located close to the point of load (<100mm). PCB design emphasizes low resistance and inductance tracks in consideration of high current applications. Output capacitors with their associated ESR values have an impact on loop stability and bandwidth. Cincon's converters are designed to work with load capacitance to see technical specifications.



EC6AW Series

Application Note V13

8. Thermal Design

8.1 Operating Temperature Range

The EC6AW series converters can be operated within a wide case temperature range of -40°C to 85°C (de-rating above 71°C). Consideration must be given to the derating curves when ascertaining maximum power that can be drawn from the converter. The maximum power drawn from models is influenced by usual factors, such as:

- Input voltage range
- Output load current
- Forced air or natural convection

8.2 Convection Requirements for Cooling

To predict the approximate cooling needed for the 1.25"×0.8" module, refer to the power derating curves in **datasheet**. These derating curves are approximations of the ambient temperatures and airflows required to keep the power module temperature below its maximum rating. Once the module is assembled in the actual system, the module's temperature should be monitored to ensure it does not exceed 100°C as measured at the center of the top of the case (thus verifying proper cooling).

8.3 Thermal Considerations

The power module operates in a variety of thermal environments; however, sufficient cooling should be provided to help ensure reliable operation of the unit. Heat is removed by conduction, convection, and radiation to the surrounding environment. The example is presented in **datasheet**. The power output of the module should not be allowed to exceed rated power ($V_{o_set} \times I_{o_max}$).

8.4 Power Derating

The operating case temperature range of EC6AW series is -40°C to 100°C. When operating the EC6AW series, proper derating or cooling is needed. The maximum case temperature under any operating condition should not exceed 100°C (refer to datasheet).



EC6AW Series Application Note V13

9. Safety & EMC

9.1 Input Fusing and Safety Considerations

The EC6AW series converters have no internal fuse. In order to achieve maximum safety and system protection, always use an input line fuse. We recommended a time delay fuse 2A for 24Vin models and 1A for 48Vin modules. It is recommended that the circuit have a transient voltage suppressor diode (TVS) across the input terminal to protect the unit against surge or spike voltage and input reverse voltage (as shown).

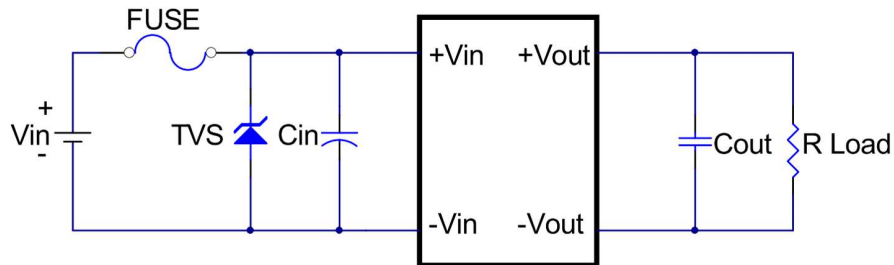

The external input capacitor (C_{in}) and transient voltage suppressor diode (TVS) are required if EC6AW series has to meet EN 61000-4-4, EN 61000-4-5.

C_{in} : a 120 μ F/220V (Nippon Chemi-Con KXJ series) aluminum capacitor is recommended.

TVS: a SMDJ180A transient voltage suppressor is recommended.

9.2 EMC Considerations

(1) EMI Test standard: EN 55032 Class A Conducted Emission

Test Condition: Input Voltage: Nominal, Output Load: Full Load

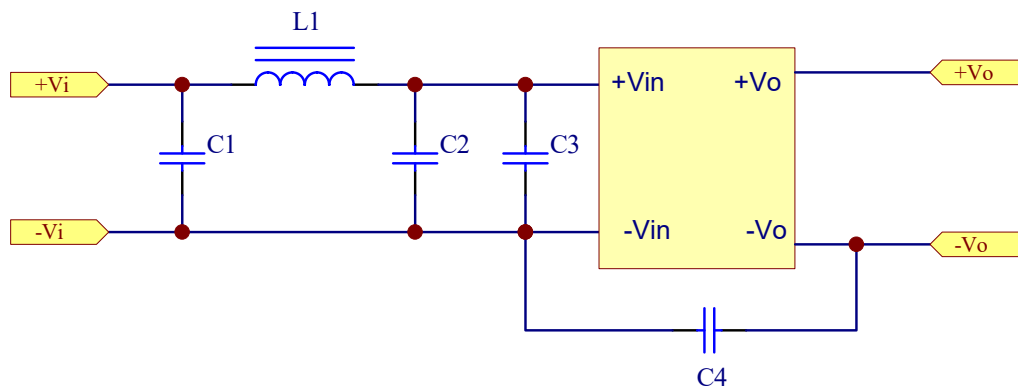

Connection circuit for conducted EMI testing



EC6AW Series Application Note V13

Model No.	EN55022 Class A					EN55022 Class B				
	C1	C2	C3	C4	L1	C1	C2	C3	C4	L1
EC6AW-24S33	10uF/50V	10uF/50V	10uF/50V	NC	Jump Wire	10uF/50V	NC	10uF/50V	NC	3.3uH
EC6AW-24S05	10uF/50V	10uF/50V	10uF/50V	NC	Jump Wire	10uF/50V	NC	10uF/50V	NC	3.3uH
EC6AW-24S12	10uF/50V	10uF/50V	10uF/50V	NC	Jump Wire	10uF/50V	NC	10uF/50V	NC	3.3uH
EC6AW-24S15	10uF/50V	10uF/50V	10uF/50V	NC	Jump Wire	10uF/50V	NC	10uF/50V	NC	3.3uH
EC6AW-24D05	10uF/50V	10uF/50V	10uF/50V	NC	Jump Wire	10uF/50V	NC	10uF/50V	NC	3.3uH
EC6AW-24D12	10uF/50V	10uF/50V	10uF/50V	NC	Jump Wire	10uF/50V	NC	10uF/50V	NC	3.3uH
EC6AW-24D15	10uF/50V	10uF/50V	10uF/50V	NC	Jump Wire	10uF/50V	NC	10uF/50V	NC	3.3uH
EC6AW-48S33	NC	4.7uF/100V	4.7uF/100V	NC	Jump Wire	4.7uF/100V	NC	4.7uF/100V	NC	2.7uH
EC6AW-48S05	NC	4.7uF/100V	4.7uF/100V	NC	Jump Wire	4.7uF/100V	NC	4.7uF/100V	NC	2.7uH
EC6AW-48S12	NC	4.7uF/100V	4.7uF/100V	NC	Jump Wire	4.7uF/100V	NC	4.7uF/100V	NC	2.7uH
EC6AW-48S15	NC	4.7uF/100V	4.7uF/100V	NC	Jump Wire	4.7uF/100V	NC	4.7uF/100V	NC	2.7uH
EC6AW-48D05	NC	4.7uF/100V	4.7uF/100V	NC	Jump Wire	4.7uF/100V	NC	4.7uF/100V	NC	2.7uH
EC6AW-48D12	NC	4.7uF/100V	4.7uF/100V	NC	Jump Wire	4.7uF/100V	NC	4.7uF/100V	NC	2.7uH
EC6AW-48D15	NC	4.7uF/100V	4.7uF/100V	NC	Jump Wire	4.7uF/100V	NC	4.7uF/100V	NC	2.7uH

Note:

All of capacitors are ceramic capacitors and 1812 size
Jump Wire: 0.4mm min



EC6AW Series Application Note V13

Conducted Class A (EN 55032):

EC6AW-24S33

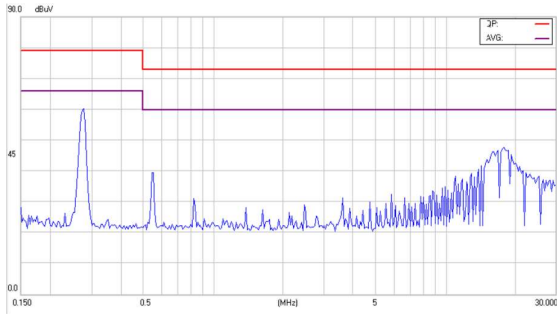

EC6AW-24S05

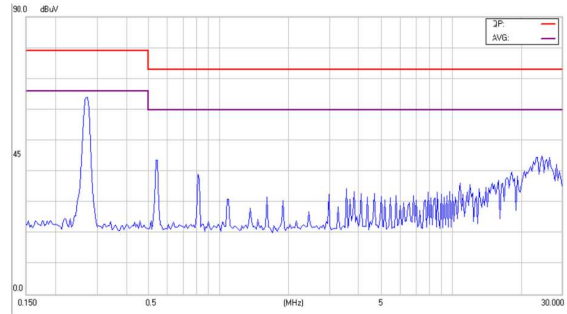

EC6AW-24S12

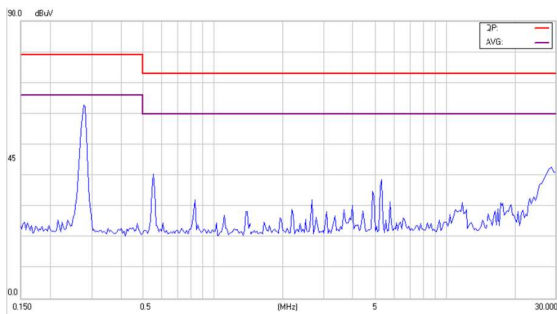

EC6AW-24S15

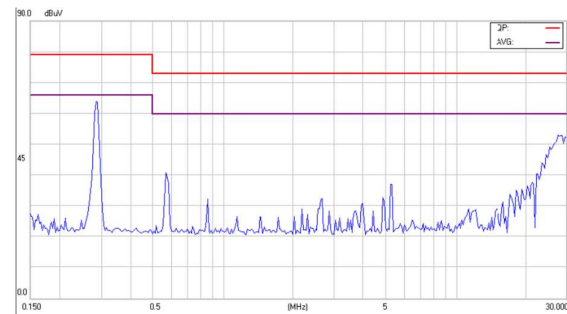

EC6AW-24D05

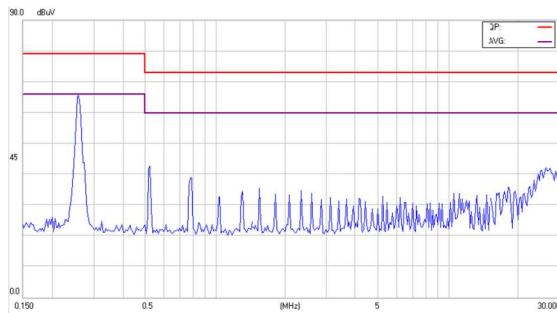

EC6AW-24D12

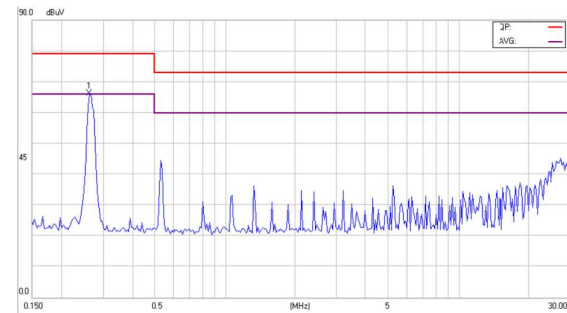

EC6AW-24D15

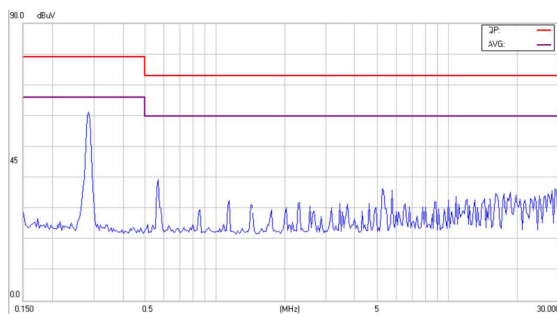

EC6AW-48S33

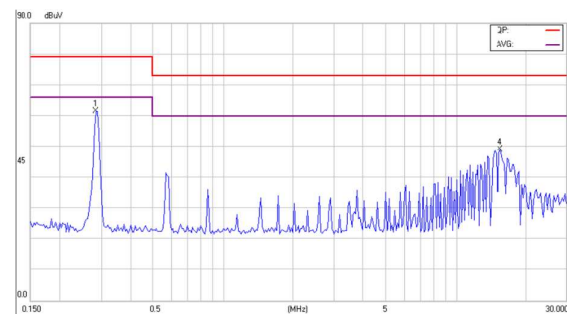



EC6AW Series Application Note V13

EC6AW-48S05

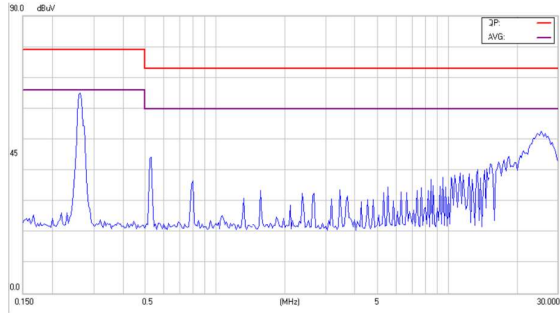

EC6AW-48S12

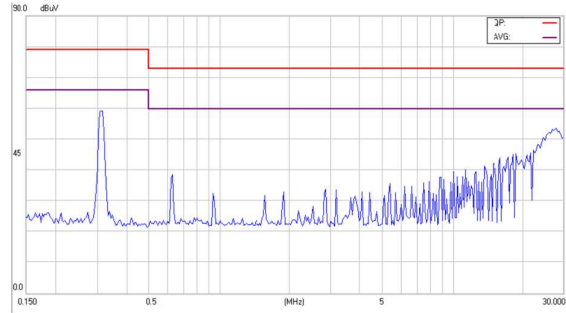

EC6AW-48S15

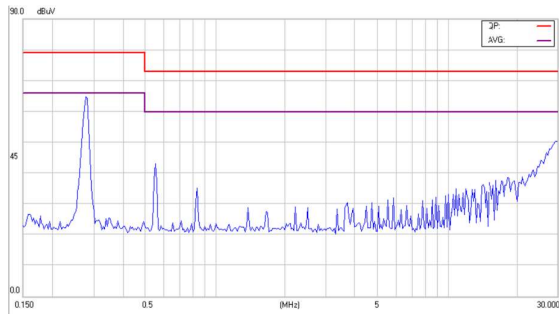

EC6AW-48D05

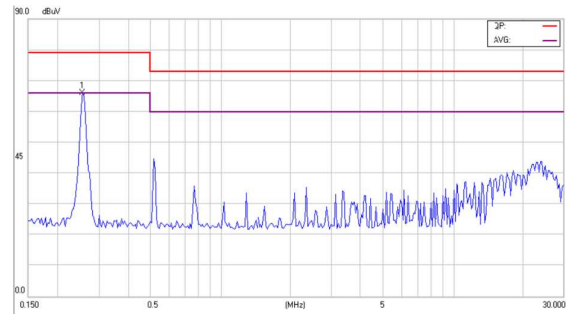

EC6AW-48D12

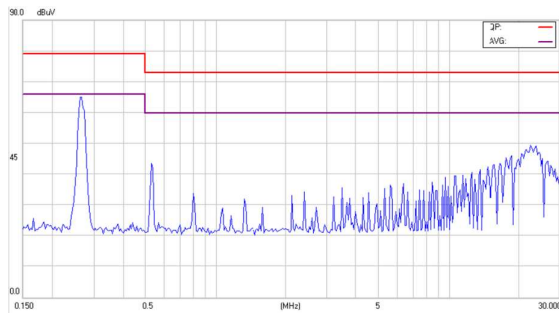

EC6AW-48D15

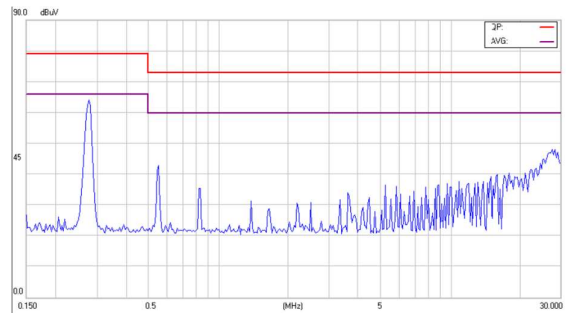



EC6AW Series Application Note V13

Conducted Class B (EN 55032):

EC6AW-24S33

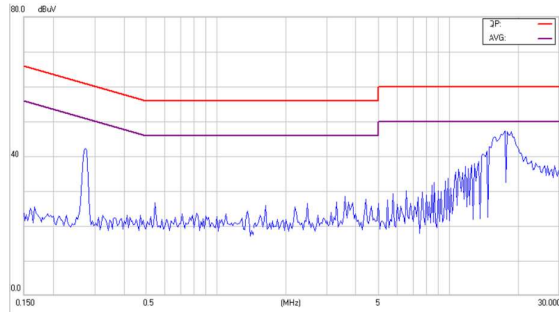

EC6AW-24S05

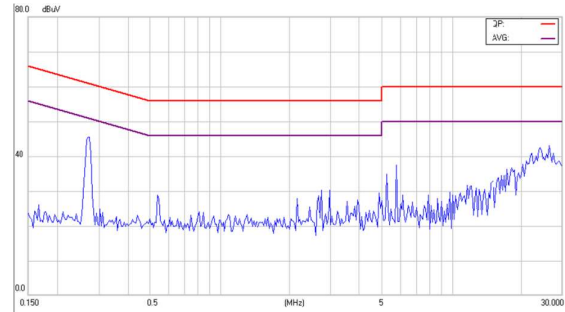

EC6AW-24S12

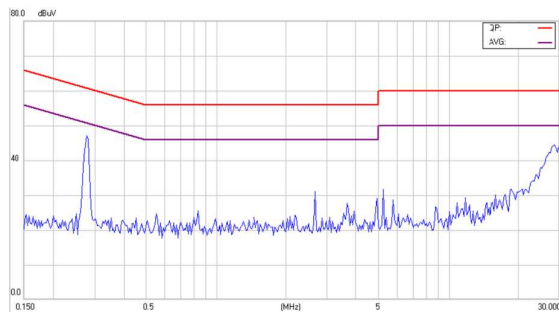

EC6AW-24S15

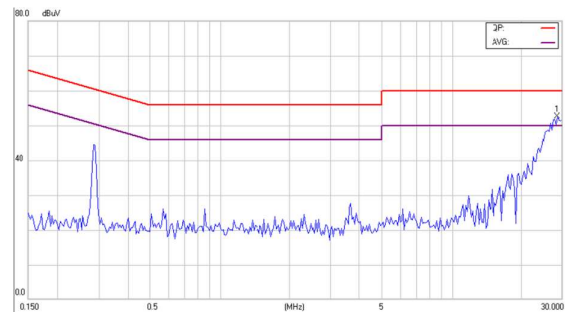

EC6AW-24D05

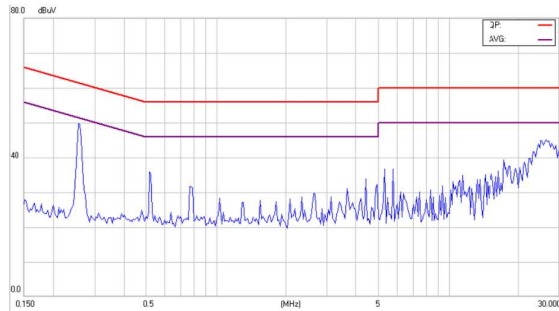

EC6AW-24D12

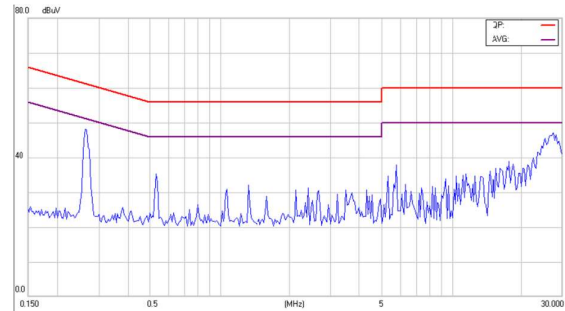

EC6AW-24D15

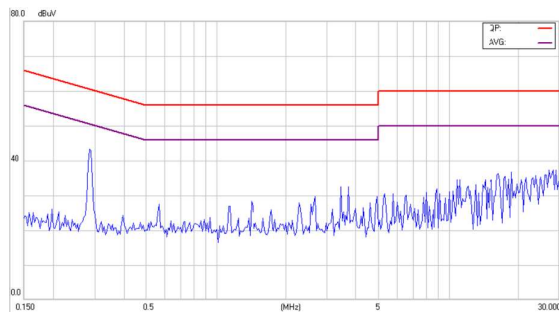

EC6AW-48S33

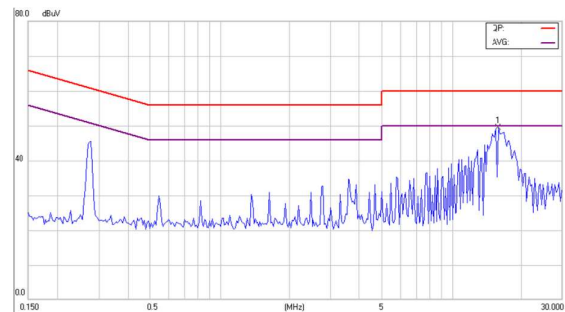



EC6AW Series Application Note V13

EC6AW-48S05

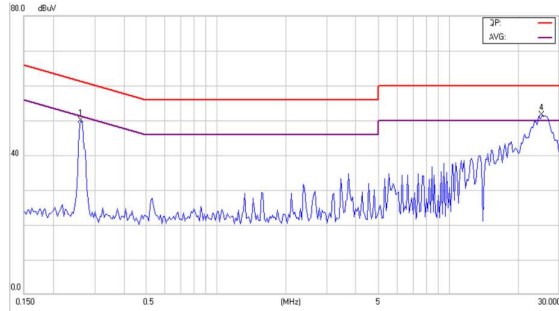

EC6AW-48S12

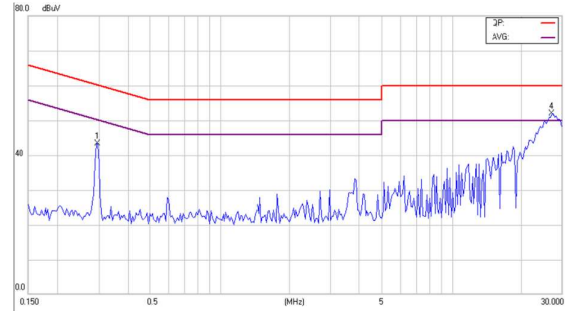

EC6AW-48S15

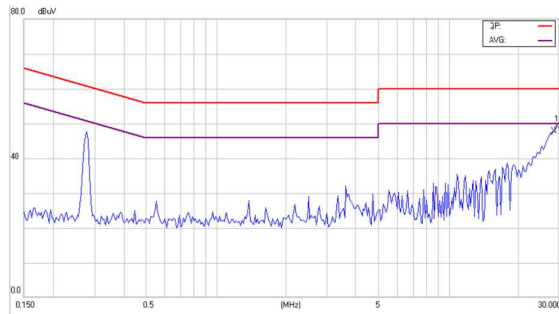

EC6AW-48D05

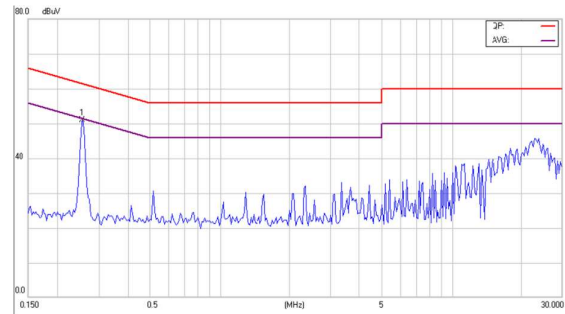

EC6AW-48D12

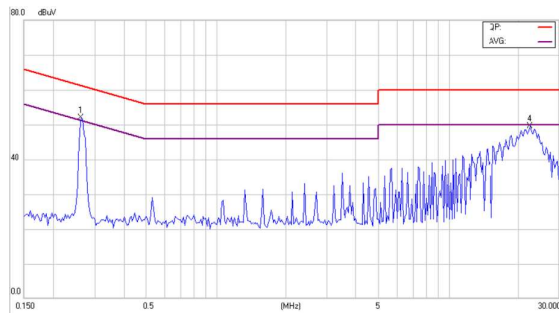

EC6AW-48D15

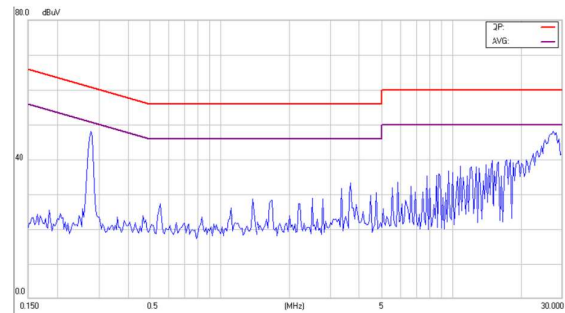



EC6AW Series Application Note V13

(2) EMI Test standard: EN 50121-3-2

Test Condition: Input Voltage: Nominal, Output Load: Full Load

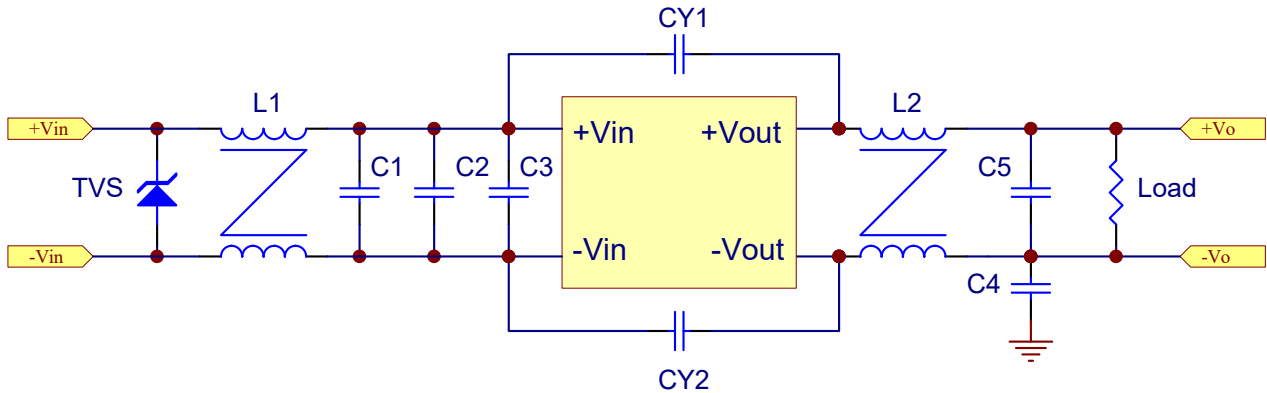

Connection circuit for Single Output

Module	EN50121-3-2							
	TVS	C1, C2	C3	C4	C5	CY1 & CY2	L1	L2
EC6AW-24S33	1.5KE47A	10uF/50V 1210 X5R	10uF/50V 1210 X5R	0.047uF/1KV 1812 X7R	1uF/100V 1206 X7R	1000pF/3KV 1808 X7R	0.77mH	108uH
EC6AW-24S05	1.5KE47A	10uF/50V 1210 X5R	10uF/50V 1210 X5R	0.047uF/1KV 1812 X7R	1uF/100V 1206 X7R	1000pF/3KV 1808 X7R	0.77mH	108uH
EC6AW-24S12	1.5KE47A	10uF/50V 1210 X5R	10uF/50V 1210 X5R	0.047uF/1KV 1812 X7R	1uF/100V 1206 X7R	1000pF/3KV 1808 X7R	0.77mH	108uH
EC6AW-24S15	1.5KE47A	10uF/50V 1210 X5R	10uF/50V 1210 X5R	0.047uF/1KV 1812 X7R	1uF/100V 1206 X7R	1000pF/3KV 1808 X7R	0.77mH	108uH
EC6AW-48S33	1.5KE91A	4.7uF/100V 1812 X7R	NC	0.047uF/1KV 1812 X7R	1uF/100V 1206 X7R	1000pF/3KV 1808 X7R	0.77mH	108uH
EC6AW-48S05	1.5KE91A	4.7uF/100V 1812 X7R	NC	0.047uF/1KV 1812 X7R	1uF/100V 1206 X7R	1000pF/3KV 1808 X7R	0.77mH	108uH
EC6AW-48S12	1.5KE91A	4.7uF/100V 1812 X7R	NC	0.047uF/1KV 1812 X7R	1uF/100V 1206 X7R	1000pF/3KV 1808 X7R	0.77mH	108uH
EC6AW-48S15	1.5KE91A	4.7uF/100V 1812 X7R	NC	0.047uF/1KV 1812 X7R	1uF/100V 1206 X7R	NC	Jump Wire	108uH

Note:

C1, C2, C3, C4, C5, CY1, CY2 are ceramic capacitors

L1: 0.77mH (VAKOS R15K T10*6*5C (ψ 0.5mm/10T) or equivalent

L2: 108uH (STEWART 35T-375-100 (ψ 1mm/7T) or equivalent

Jump Wire: 0.4mm min



EC6AW Series Application Note V13

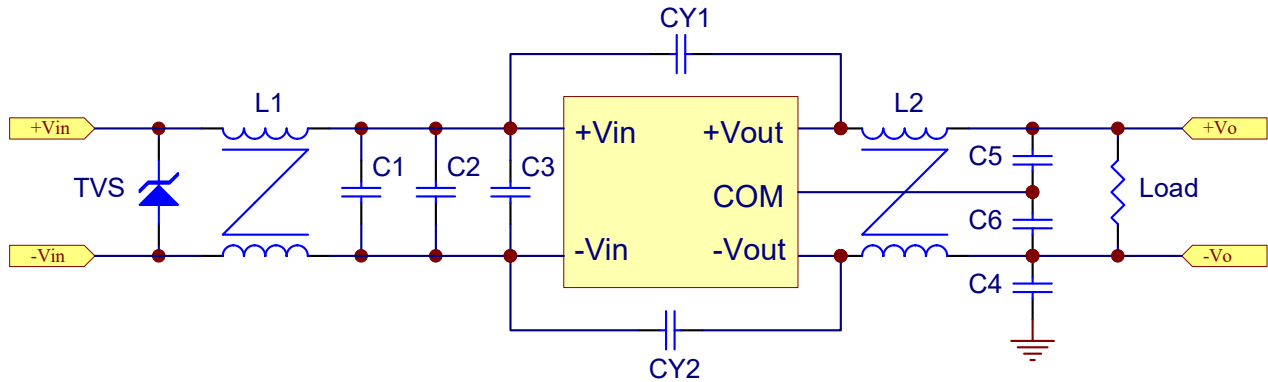

Connection circuit for Dual Output

Module	EN50121-3-2							
	TVS	C1, C2	C3	C4	C5, C6	CY1 & CY2	L1	L2
EC6AW-24D05	1.5KE47A	10uF/50V 1210 X5R	10uF/50V 1210 X5R	0.047uF/1KV 1812 X7R	1uF/100V 1206 X7R	1000pF/3KV 1808 X7R	0.77mH	108uH
EC6AW-24D12	1.5KE47A	10uF/50V 1210 X5R	10uF/50V 1210 X5R	0.047uF/1KV 1812 X7R	1uF/100V 1206 X7R	1000pF/3KV 1808 X7R	0.77mH	108uH
EC6AW-24D15	1.5KE47A	10uF/50V 1210 X5R	10uF/50V 1210 X5R	0.047uF/1KV 1812 X7R	1uF/100V 1206 X7R	NC	Jump Wire	108uH
EC6AW-48D05	1.5KE91A	4.7uF/100V 1812 X7R	NC	0.047uF/1KV 1812 X7R	1uF/100V 1206 X7R	1000pF/3KV 1808 X7R	0.77mH	108uH
EC6AW-48D12	1.5KE91A	4.7uF/100V 1812 X7R	NC	0.047uF/1KV 1812 X7R	1uF/100V 1206 X7R	1000pF/3KV 1808 X7R	0.77mH	108uH
EC6AW-48D15	1.5KE91A	4.7uF/100V 1812 X7R	NC	0.047uF/1KV 1812 X7R	1uF/100V 1206 X7R	1000pF/3KV 1808 X7R	0.77mH	108uH

Note:

- C1, C2, C3, C4, C5, C6, CY1, CY2 are ceramic capacitors
- L1: 0.77mH (VAKOS R15K T10*6*5C (φ0.5mm/10T) or equivalent
- L2: 108uH (STEWART 35T-375-100 (φ1mm/7T) or equivalent
- Jump Wire: 0.4mm min



EC6AW Series Application Note V13

Input Conducted Emission (EN 50121-3-2):

EC6AW-24D33

Line

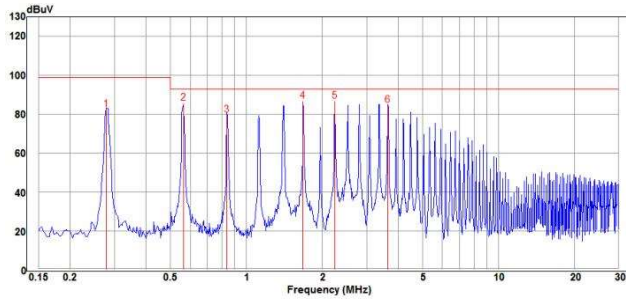

Neutral

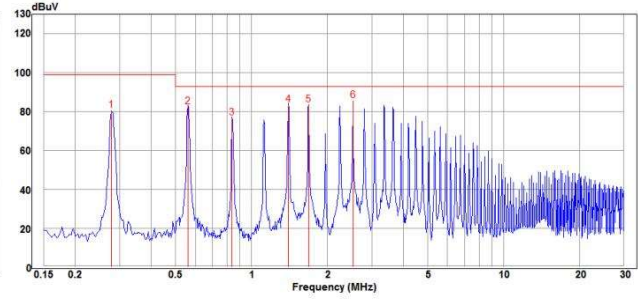

EC6AW-48S15

Line

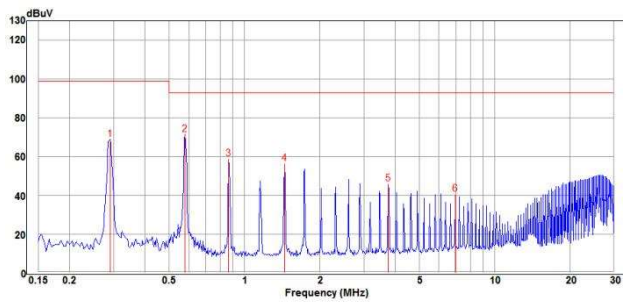

Neutral

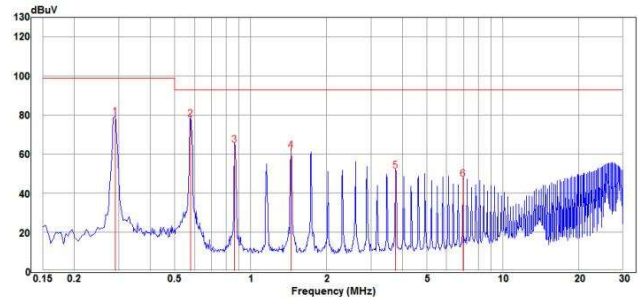

Output Conducted Emission (EN 50121-3-2):

EC6AW-24D15

Positive

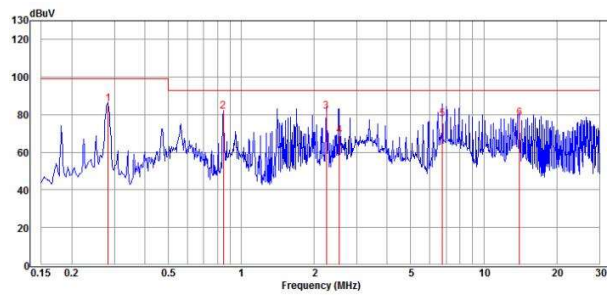

Negative

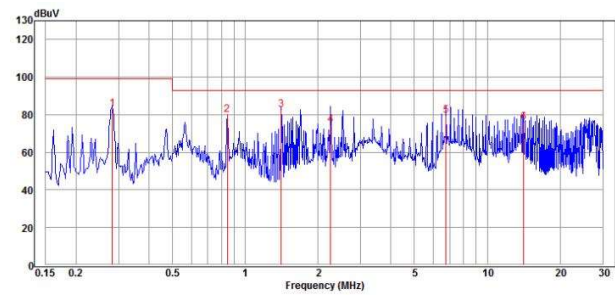



EC6AW Series Application Note V13

EC6AW-48S15

Positive

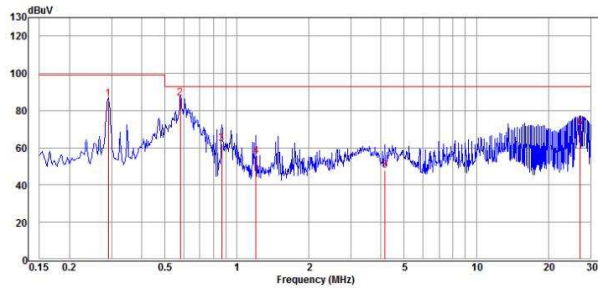

Negative

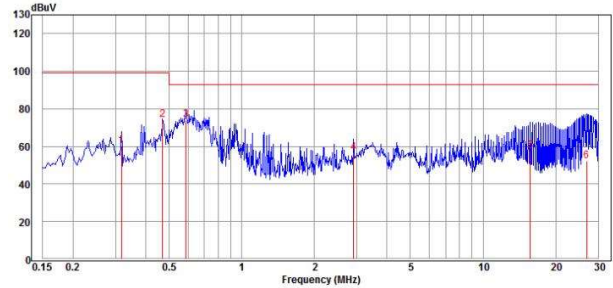

Radiated Emission (EN 50121-3-2):

EC6AW-24D15

Horizontal

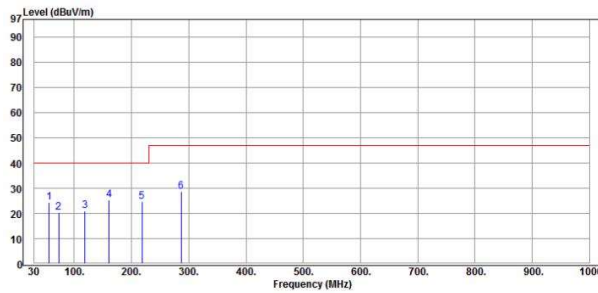

Vertical

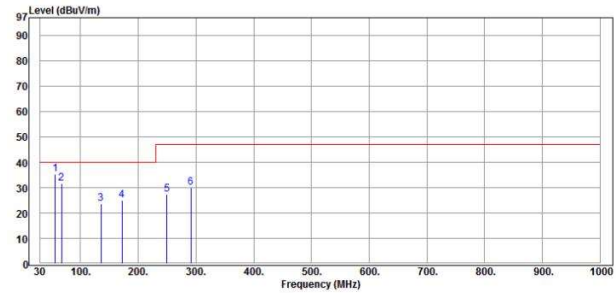

EC6AW-48S15

Horizontal

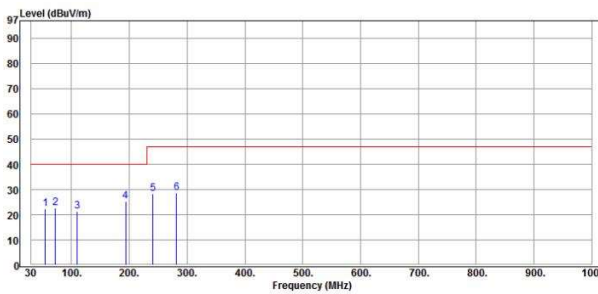

Vertical

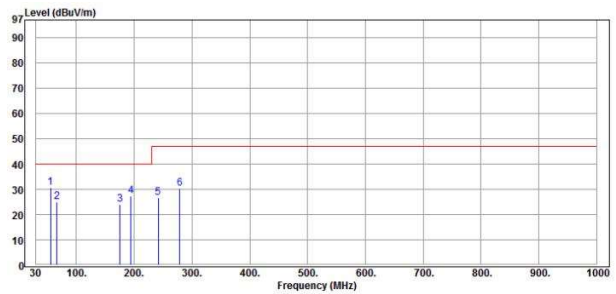

Headquarters:

14F, No.306, Sec.4, Hsin Yi Rd.
Taipei, Taiwan
Tel: 886-2-27086210
Fax: 886-2-27029852
E-mail: sales@cincon.com.tw
Web Site: <https://www.cincon.com>

CINCON ELECTRONICS CO., LTD.

Factory:

No. 8-1, Fu Kung Rd.
Fu Hsing Industrial Park
Fu Hsing Hsiang,
ChangHua Hsien, Taiwan
Tel: 886-4-7690261
Fax: 886-4-7698031

Cincon North America:

1655Mesa Verde Ave. Ste 180
Ventura, CA93003
Tel: 805-639-3350
Fax: 805-639-4101
E-mail: info@cincon.com