



# EC7BW18 Series Application Note V14

## ISOLATED DC-DC CONVERTER EC7BW18 SERIES APPLICATION NOTE



### Approved By:

Department	Approved By	Checked By	Written By
Research and Development Department	Jacky	Danny	Wade
Design Quality Department	Benny	JoJo	



# EC7BW18 Series Application Note V14

## Contents

1. Introduction .....	3
2. Pin Function Description .....	3
3. Connection for Standard Use .....	4
4. Test Set-Up .....	4
5. Recommend Layout, PCB Footprint and Soldering Information .....	4
6. Features and Functions .....	5
6.1 UVLO (Under Voltage Lock Out) .....	5
6.2 Over Current/Short Circuit Protection .....	5
6.3 Output Over Voltage Protection .....	5
6.4 Over Temperature Protection .....	6
6.5 Remote On/Off .....	6
6.6 Output Voltage Adjustment .....	7
7. Input / Output Considerations .....	8
7.1 Input Capacitance at the Power Module .....	8
7.2 Hold Up Time .....	8
7.3 Input Derating Curve .....	9
7.4 Output Ripple and Noise .....	9
7.5 Output Capacitance .....	9
8. Thermal Design .....	10
8.1 Operating Temperature Range .....	10
8.2 Convection Requirements for Cooling .....	10
8.3 Thermal Considerations .....	10
8.4 Power Derating .....	10
8.5 2"x1" Case Heat Sinks Kit: .....	11
9. Safety & EMC .....	12
9.1 Input Fusing and Safety Considerations .....	12
9.2 EMC Considerations .....	12
9.3 Suggested Configuration for RIA12 Surge Test .....	21



# EC7BW18 Series Application Note V14

## 1. Introduction

The EC7BW18 series of DC-DC converters offers 20 watts of output power @ output voltages of 5, 12, 15,  $\pm 12$ ,  $\pm 15$ ,  $\pm 24$ VDC with industry 2"x1"x0.4" package. It has a ultra wide (18:1) input voltage range of 8.5 to 160VDC (72VDC nominal) and 3000VAC reinforced isolation.

Compliant with EN55032, EN55035, EN50155, EN45545, EN50121-3-2. High efficiency up to 90%, allowing case operating temperature range of  $-40^{\circ}\text{C}$  to  $105^{\circ}\text{C}$ . An optional heat sink is available to extend the full power range of the unit. Very low no load power consumption (8mA), an ideal solution for energy critical systems.

Fully protected against input UVLO (under voltage lock out), output over-current, output over-voltage and over-temperature and continuous short circuit conditions.

The standard control functions include remote on/off (positive or negative) and +15%, -20% adjustable output voltage (single output only).

EC7BW18 series is designed primarily for common railway applications of 24V, 36V, 48V, 72V, 96V, 110V nominal voltage and also suitable for distributed power architectures, telecommunications, battery operated equipment and industrial applications.

## 2. Pin Function Description

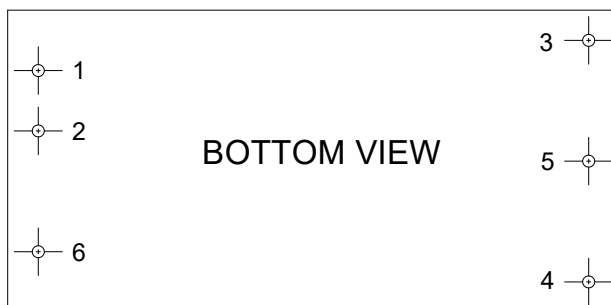

### Single Output

No	Label	Function	Description	Reference
1	+Vin	+V Input	Positive Supply Input	<b>Section 7.1/7.2/ 7.3</b>
2	-Vin	-V Input	Negative Supply Input	<b>Section 7.1/7.2/ 7.3</b>
3	+Vout	+V Output	Positive Power Output	<b>Section 7.4/7.5</b>
4	Trim	Trim	External Output Voltage Adjustment	<b>Section 6.6</b>
5	-Vout	-V Output	Negative Power Output	<b>Section 7.4/7.5</b>
6	Remote	Remote On/Off	External Remote On/Off Control	<b>Section 6.5</b>

### Dual Output

No	Label	Function	Description	Reference
1	+Vin	+V Input	Positive Supply Input	<b>Section 7.1/7.2/ 7.3</b>
2	-Vin	-V Input	Negative Supply Input	<b>Section 7.1/7.2/ 7.3</b>
3	+Vout	+V Output	Positive Power Output	<b>Section 7.4/7.5</b>
4	-Vout	-V Output	Negative Power Output	<b>Section 7.4/7.5</b>
5	Com	Common	Common Power Output	<b>Section 7.4/7.5</b>
6	Remote	Remote On/Off	External Remote On/Off Control	<b>Section 6.5</b>



# EC7BW18 Series Application Note V14

## 3. Connection for Standard Use

The connection for standard use is shown below. External output capacitors (C1, C2) are recommended to reduce output ripple and noise, 1uF ceramic capacitor for all models.

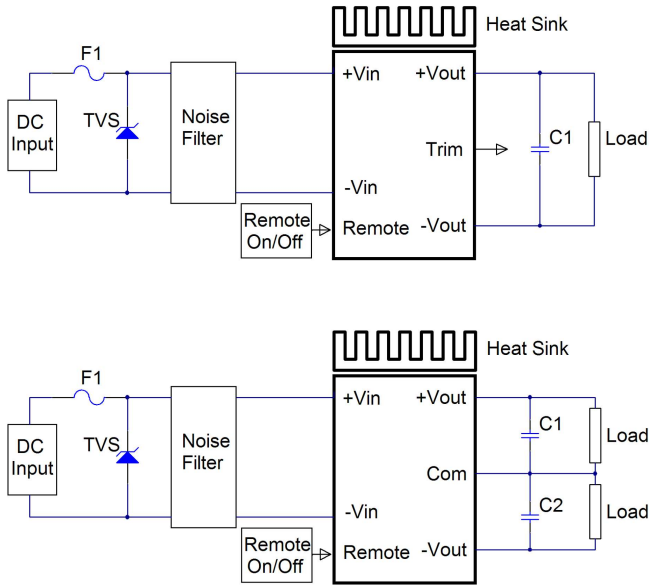

Symbol	Component	Reference
F1, TVS	Input fuse, TVS	Section 9.1
C1, C2	External capacitor on the output side	Section 7.4
Noise Filter	External input noise filter	Section 9.2
Remote On/Off	External remote on/off control	Section 6.5
Trim	External output voltage adjustment	Section 6.6
Heat sink	External heat sink	Section 8.1/8.2/8.3/8.4/8.5

## 4. Test Set-Up

The basic test set-up to measure parameters such as efficiency and load regulation is shown below. When testing the modules under any transient conditions please ensure that the transient response of the source is sufficient to power the equipment under test. We can calculate:

- Efficiency
- Load regulation and line regulation

The value of efficiency is defined as:

$$\eta = \frac{V_o \times I_o}{V_{in} \times I_{in}} \times 100\%$$

Where:

- $V_o$  is output voltage
- $I_o$  is output current
- $V_{in}$  is input voltage
- $I_{in}$  is input current

The value of load regulation is defined as:

$$Load\ reg. = \frac{V_{FL} - V_{NL}}{V_{NL}} \times 100\%$$

Where:

- $V_{FL}$  is the output voltage at full load
- $V_{NL}$  is the output voltage at no load

The value of line regulation is defined as:

$$Line\ reg. = \frac{V_{HL} - V_{LL}}{V_{LL}} \times 100\%$$

Where:

- $V_{HL}$  is the output voltage of maximum input voltage at full load
- $V_{LL}$  is the output voltage of minimum input voltage at full load

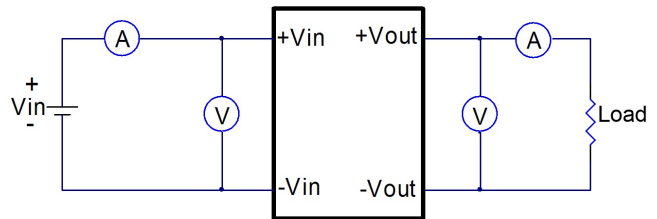

EC7BW18-72 Series Test Setup

## 5. Recommend Layout, PCB Footprint and Soldering Information

The system designer or end user must ensure that metal and other components in the vicinity of the converter meet the spacing requirements for which the system is approved. Low resistance and inductance PCB layout traces are the norm and should be used where possible. Due consideration must also be given to proper low impedance tracks between power module, input and output grounds. The recommended footprints and soldering profiles are shown below.



# EC7BW18 Series Application Note V14

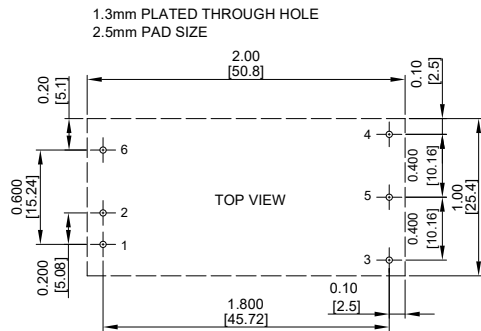

Note: Dimensions are in inches (millimeters)

Clean the soldered side of the module with a brush, prevent liquid from getting into the module. Do not clean by soaking the module into liquid. Do not allow solvent to come in contact with product labels or resin case as this may change the color of the resin case or cause deletion of the letters printed on the product label. After cleaning, dry the modules well.

The suggested soldering iron is  $420 \pm 10^\circ\text{C}$  for up to 4~15seconds (less than 90W). Furthermore, the recommended soldering profile is shown below.

Lead Free Wave Soldering Profile

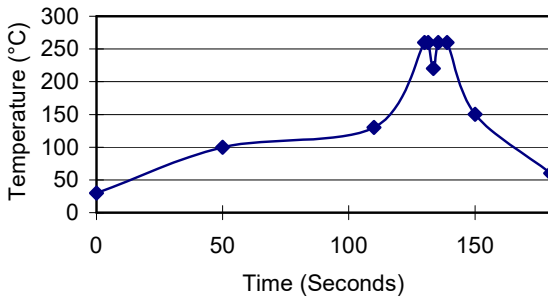

## 6. Features and Functions

### 6.1 UVLO (Under Voltage Lock Out)

Input under voltage lockout is standard on the EC7BW18-72 series unit. The unit will shut down when the input voltage drops below a lower threshold, and the unit will operate when the input voltage goes above the upper threshold.

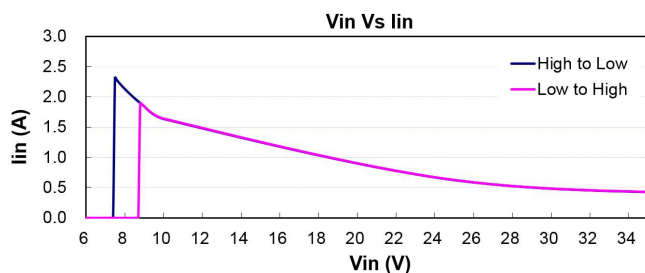

### 6.2 Over Current/Short Circuit Protection

All models have internal over current and continuous short circuit protection. The unit operates normally once the fault condition is removed. At the point of current limit inception, the converter will go into hiccup mode protection.

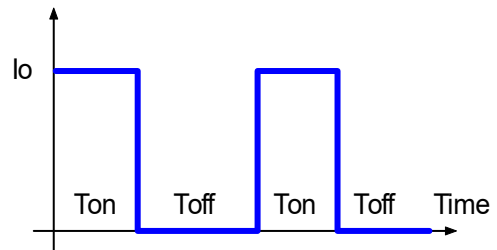
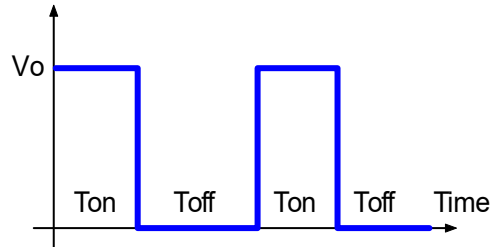

### 6.3 Output Over Voltage Protection

The over-voltage protection consists of a zener diode to limiting the out voltage.



# EC7BW18 Series Application Note V14

## 6.4 Over Temperature Protection

These modules have an over temperature protection circuit to safeguard against thermal damage. Shutdown occurs with the maximum case reference temperature is exceeded. The module will restart when the case temperature falls below over temperature recovery threshold. Different input voltage the over temperature protection turn on/off points will drift. Please measure temperature of the center part of plastic case.

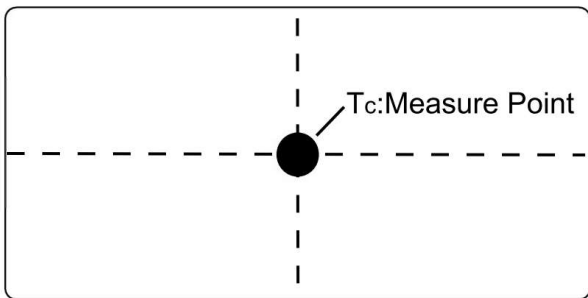
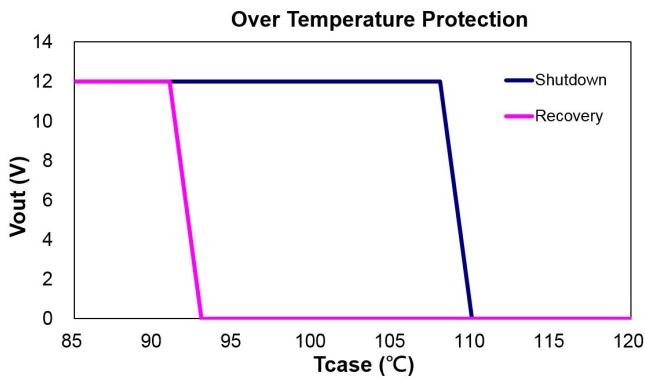

TOP VIEW

## 6.5 Remote On/Off

The EC7BW18-72 series allows the user to switch the module on and off electronically with the remote on/off feature. All models are available in "positive logic" and "negative logic" (optional) versions. The converter turns on if the remote On/Off pin is high (>4.0Vdc to 160Vdc or open circuit). Setting the pin low (0 to <1.2Vdc) will turn the converter off. The signal level of the remote on/off input is defined with respect to ground.

If not using the remote on/off pin, leave the pin open (converter will be on). Converter will be turn on in positive mode.

Models with part number suffix "N" are the "negative logic" remote on/off version. The unit turns off if the remote on/off pin is high (>4.0Vdc to 160Vdc or open circuit). The converter turns on if the On/Off pin input is low (0 to <1.2Vdc). Note that the converter is off by default.

Logic State (Pin 6)	Negative Logic	Positive Logic
Logic Low	Module on	Module off
Logic High	Module off	Module on

The converter remote on/off circuit built-in on input side. The ground pin of input side remote on/off circuit is -vin pin. Inside connection sees below.

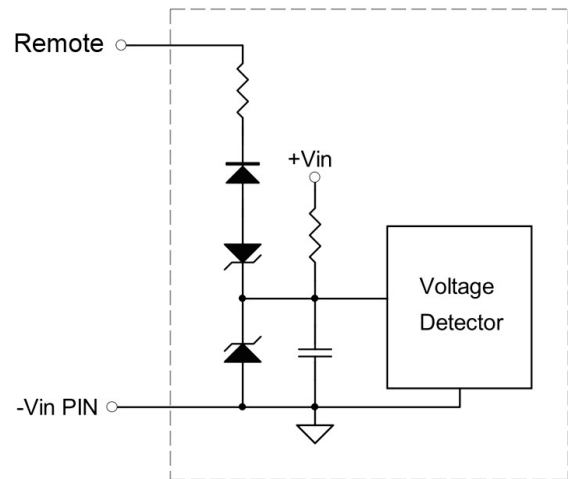

Connection examples see below.

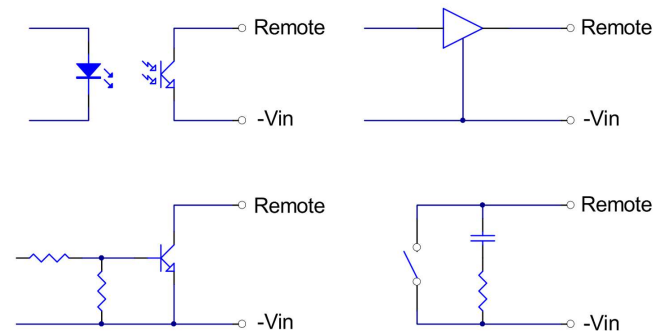

Remote On/Off Connection Examples



# EC7BW18 Series Application Note V14

## 6.6 Output Voltage Adjustment

Output may be externally trimmed -20% to +15% (single output models only) with a fixed resistor or an external trim pot as shown (optional). Model specific formulas for calculating trim resistors are available upon request as a separate document.

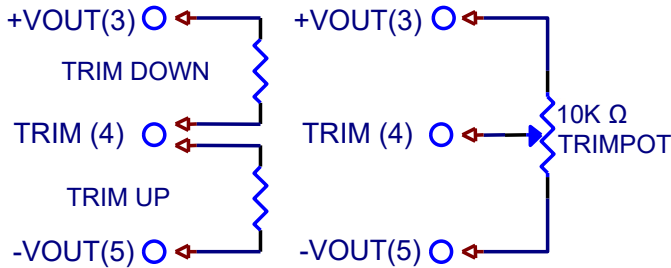

In order to trim the voltage up or down, one needs to connect the trim resistor either between the trim pin and -Vout for trim-up or between trim pin and +Vout for trim-down. The output voltage trim range is -20% to +15%. This is shown:

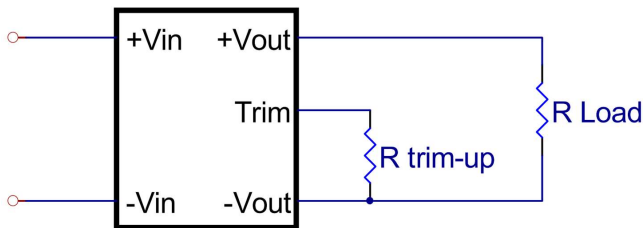

Trim-up Voltage Setup

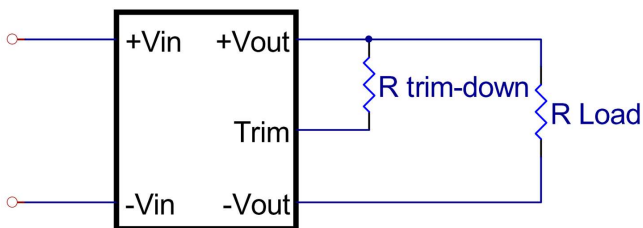

Trim-down Voltage Setup

The EC7BW18-72S05 value of  $R_{trim\_up}$  defined as:

$$R_{trim\_up} = \frac{22.13 - 3.976 \times (V_o - V_{o,nom})}{7.017 \times (V_o - V_{o,nom})} - 3.3 \quad (K\Omega)$$

The EC7BW18-72S12 value of  $R_{trim\_up}$  defined as:

$$R_{trim\_up} = \frac{120.76}{3 \times (V_o - V_{o,nom})} - 18 \quad (K\Omega)$$

The EC7BW18-72S15 value of  $R_{trim\_up}$  defined as:

$$R_{trim\_up} = \frac{104.42}{2.28 \times (V_o - V_{o,nom})} - 18 \quad (K\Omega)$$

Where:

$R_{trim\_up}$  is the external resistor in K $\Omega$

$V_{o,nom}$  is the nominal output voltage

$V_o$  is the desired output voltage

For example, to trim-up the output voltage of 5V module (EC7BW18-72S05) by 5% to 5.25V,  $R_{trim\_up}$  is calculated as follows:

$$R_{trim\_up} = \frac{22.13 - 3.976 \times (5.25 - 5)}{7.017 \times (5.25 - 5)} - 3.3 = 8.75 \quad (K\Omega)$$

The typical value of  $R_{trim\_up}$

Trim up %	5V	12V	15V
	$R_{trim\_up}$ (K $\Omega$ )		
1%	59.21	317.46	287.32
2%	27.67	149.73	134.66
3%	17.16	93.82	83.77
4%	11.90	65.86	58.33
5%	8.75	49.09	43.06
6%	6.65	37.91	32.89
7%	5.14	29.92	25.62
8%	4.02	23.93	20.17
9%	3.14	19.27	15.92
10%	2.44	15.55	12.53
11%	1.87	12.50	9.76
12%	1.39	9.95	7.44
13%	0.99	7.80	5.49
14%	0.64	5.96	3.81
15%	0.34	4.36	2.35

The EC7BW18-72S05 value of  $R_{trim\_down}$  defined as:

$$R_{trim\_down} = \frac{42 - 16.803 \times (V_o, nom - V_o)}{7.017 \times (V_o, nom - V_o)} - 3.3 \quad (K\Omega)$$

The EC7BW18-72S12 value of  $R_{trim\_down}$  defined as:

$$R_{trim\_down} = \frac{206.116}{3 \times (V_o, nom - V_o)} - 27.08 \quad (K\Omega)$$

The EC7BW18-72S15 value of  $R_{trim\_down}$  defined as:

$$R_{trim\_down} = \frac{206.116}{2.28 \times (V_o, nom - V_o)} - 27.08 \quad (K\Omega)$$

Where:

$R_{trim\_down}$  is the external resistor in K $\Omega$

$V_{o,nom}$  is the nominal output voltage

$V_o$  is the desired output voltage

For example: to trim-down the output voltage of 12V module (EC7BW18-72S12) by 5% to 11.4V,  $R_{trim\_down}$  is calculated as follows:

$$R_{trim\_down} = \frac{206.116}{3 \times (12 - 11.4)} - 27.08 = 87.43 \quad (K\Omega)$$



# EC7BW18 Series Application Note V14

The typical value of  $R_{trim\_down}$

Trim down %	5V	12V	15V
	$R_{trim\_down}$ (K $\Omega$ )		
1%	114.03	545.46	575.60
2%	54.17	259.19	274.26
3%	34.21	163.77	173.81
4%	24.24	116.06	123.59
5%	18.25	87.43	93.46
6%	14.26	68.34	73.37
7%	11.41	54.71	59.02
8%	9.27	44.49	48.25
9%	7.61	36.54	39.88
10%	6.28	30.17	33.19
11%	5.19	24.97	27.71
12%	4.28	20.63	23.14
13%	3.52	16.96	19.28
14%	2.86	13.82	15.97
15%	2.29	11.09	13.10
16%	1.79	8.70	10.59
17%	1.35	6.60	8.37
18%	0.96	4.73	6.40
19%	0.61	3.05	4.64
20%	0.29	1.55	3.05

The EC7BW18-72S05 models is adjustable within the range of -20% to +15%. For EC7BW18-72S12 and EC7BW18-72S15 models, see input & output trim curves for trim up and trim down ranges.

EC7BW18-72S12 Trim Curve

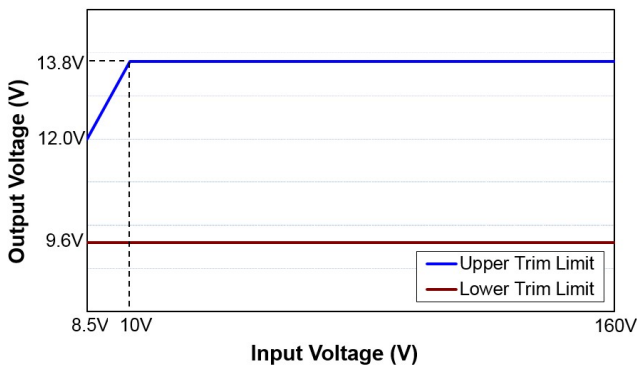

EC7BW18-72S15 Trim Curve

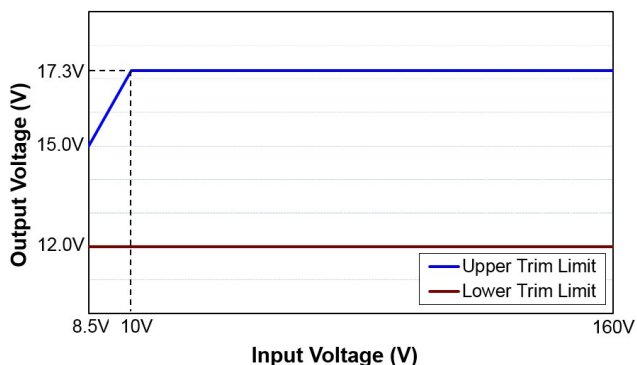

## 7. Input / Output Considerations

### 7.1 Input Capacitance at the Power Module

The converters must be connected to low AC source impedance. To avoid problems with loop stability source inductance should be low. Also, the input capacitors ( $C_{in}$ ) should be placed close to the converter input pins to decouple distribution inductance. However, the external input capacitors are chosen for suitable ripple handling capability. Low ESR capacitors are good choice. Circuit as shown as below represents typical measurement methods for reflected ripple current.  $C_1$  and  $L_1$  simulate a typical DC source impedance. The input reflected-ripple current is measured by current probe to oscilloscope with a simulated source inductance ( $L_1$ ).

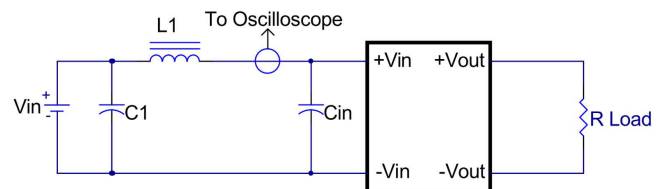

$L_1$ : 12 $\mu$ H

$C_1$ : None

$C_{in}$ : 68 $\mu$ F ESR<0.7 $\Omega$  @100KHz

### 7.2 Hold Up Time

Hold up time is defined as the duration of time that the DC/DC converter output will remain active following a loss of input power. To meet power supply interruptions, an external circuit is required, shown below.

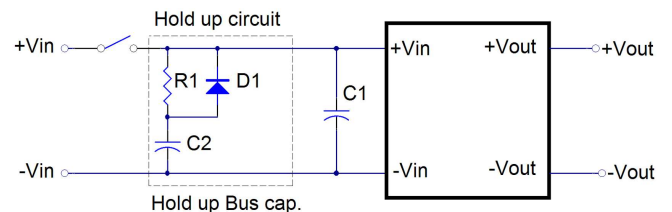

$D_1$ : 200V/10A

$R_1$ : 100 $\Omega$ /10W

$C_1$ : None

$C_2$  (Hold up Bus cap.): See below table

Input Voltage	24Vdc	36Vdc	48Vdc
Hold up time for 10ms	1100 $\mu$ F	460 $\mu$ F	250 $\mu$ F
Hold up time for 30ms	3300 $\mu$ F	1400 $\mu$ F	750 $\mu$ F
Input Voltage	72Vdc	96Vdc	110Vdc
Hold up time for 10ms	110 $\mu$ F	68 $\mu$ F	50 $\mu$ F
Hold up time for 30ms	330 $\mu$ F	200 $\mu$ F	150 $\mu$ F





# EC7BW18 Series Application Note V14

## 7.3 Input Derating Curve

EC7BW18-72 series has derating by Input Voltage is required shown below.

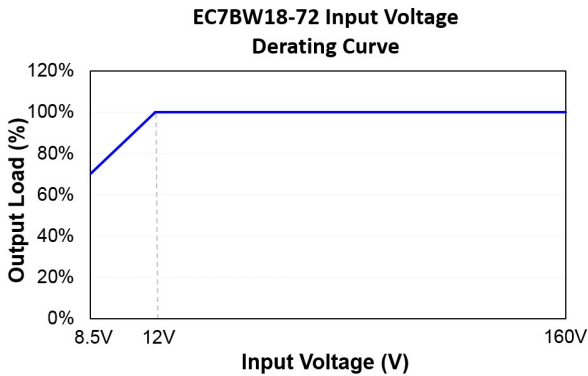

## 7.4 Output Ripple and Noise

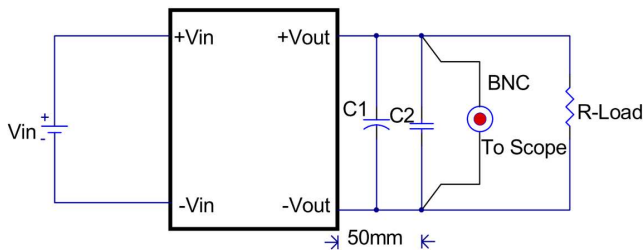

Note: C1: None, C2: 1uF ceramic capacitor.  
EC7BW18-72 single output module

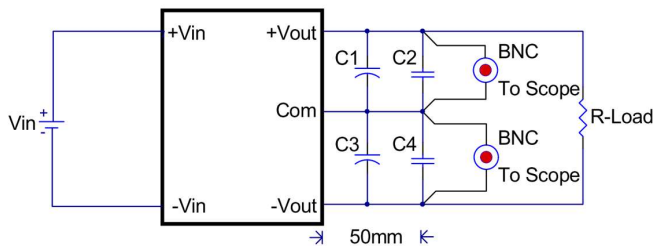

Note: C1 & C3: None, C2 & C4: 1uF ceramic capacitor.  
EC7BW18-72 dual output module

Output ripple and noise measured with 1uF ceramic capacitor across output, A 20 MHz bandwidth oscilloscope is normally used for the measurement.

The conventional ground clip on an oscilloscope probe should never be used in this kind of measurement. This clip, when placed in a field of radiated high frequency energy, acts as an antenna or inductive pickup loop, creating an extraneous voltage that is not part of the output noise of the converter.

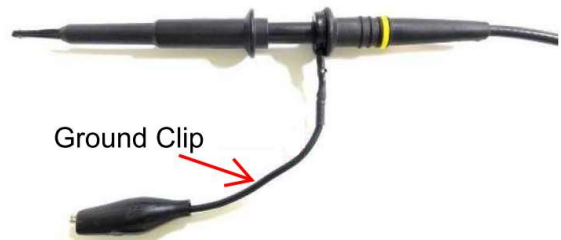

Another method is shown in below, in case of coaxial-cable/BNC is not available. The noise pickup is eliminated by pressing scope probe ground ring directly against the -Vout terminal while the tip contacts the +Vout terminal. This makes the shortest possible connection across the output terminals.

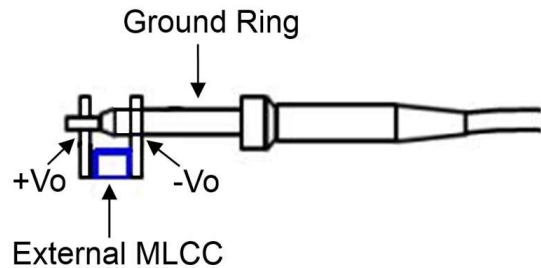

## 7.5 Output Capacitance

The EC7BW18-72 series converters provide unconditional stability with or without external capacitors. For good transient response, low ESR output capacitors should be located close to the point of load (<100mm). PCB design emphasizes low resistance and inductance tracks in consideration of high current applications. Output capacitors with their associated ESR values have an impact on loop stability and bandwidth. Cincon's converters are designed to work with load capacitance to see technical specifications.



# EC7BW18 Series Application Note V14

## 8. Thermal Design

### 8.1 Operating Temperature Range

The EC7BW18-72 series converters can be operated within a wide case temperature range of  $-40^{\circ}\text{C}$  to  $105^{\circ}\text{C}$ . Consideration must be given to the derating curves when ascertaining maximum power that can be drawn from the converter. The maximum power drawn from models is influenced by usual factors, such as:

- Input voltage range
- Output load current
- Forced air or natural convection
- Heat sink optional

### 8.2 Convection Requirements for Cooling

To predict the approximate cooling needed for the 2"×1" module, refer to the power derating curves in **section 8.4**. These derating curves are approximations of the ambient temperatures and airflows required to keep the power module temperature below its maximum rating. Once the module is assembled in the actual system, the module's temperature should be monitored to ensure it does not exceed  $105^{\circ}\text{C}$  as measured at the center of the top of the case (thus verifying proper cooling).

### 8.3 Thermal Considerations

The power module operates in a variety of thermal environments; however, sufficient cooling should be provided to help ensure reliable operation of the unit. Heat is removed by conduction, convection, and radiation to the surrounding environment. The example is presented in **section 8.4**. The power output of the module should not be allowed to exceed rated power ( $V_{o\_set} \times I_{o\_max}$ ).

### 8.4 Power Derating

The operating case temperature range of EC7BW18-72 series is  $-40^{\circ}\text{C}$  to  $+105^{\circ}\text{C}$ . When operating the EC7BW18-72 series, proper derating or cooling is needed. The maximum case temperature under any operating condition should not exceed  $105^{\circ}\text{C}$ .

The following curve is the de-rating curve of EC7BW18-72 series with heat sink.

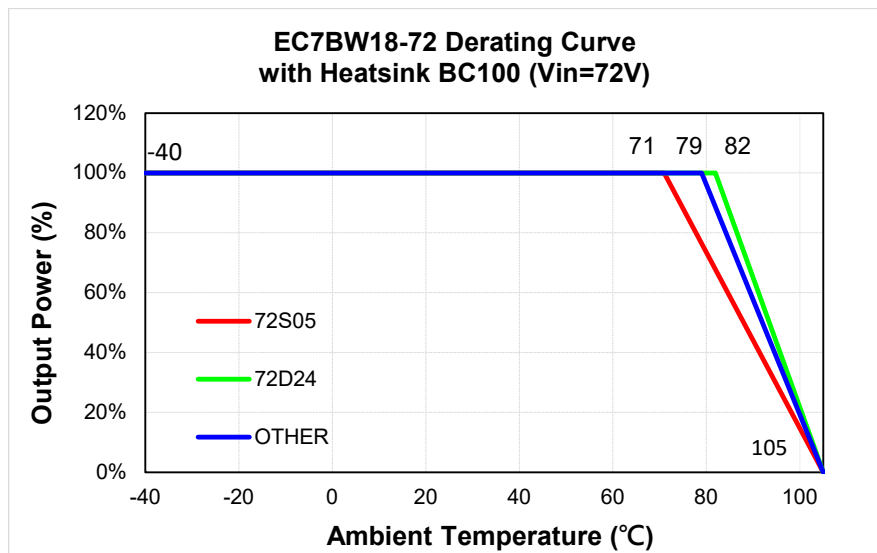

AIR FLOW RATE	TYPICAL $R_{ca}$
Natural Convection 20ft./min. (0.1m/s)	10.2 $^{\circ}\text{C}/\text{W}$



# EC7BW18 Series Application Note V14

## 8.5 2"x1" Case Heat Sinks Kit:

### Cross Cut Heat Sink: BC100 (K-C088)

All Dimensions in mm

Rca: 10.2 °C/W (typ.), at natural convection

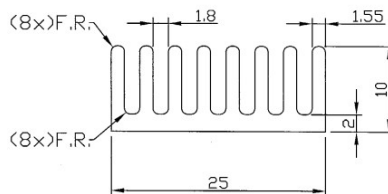
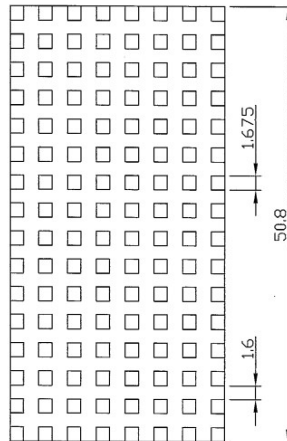

### Assembly:

Heat Sink: BC100

Clip: HC01

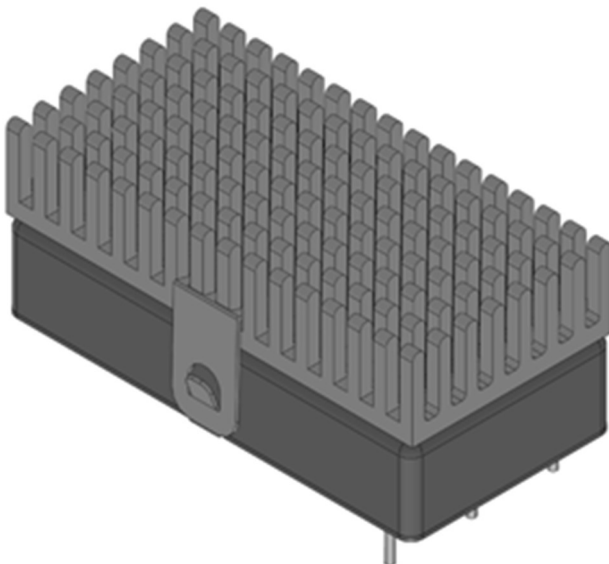



# EC7BW18 Series Application Note V14

## 9. Safety & EMC

### 9.1 Input Fusing and Safety Considerations

The EC7BW18-72 series converters have no internal fuse. In order to achieve maximum safety and system protection, always use an input line fuse. We recommended a 3.15A time delay fuse for all models. It is recommended that the circuit have a transient voltage suppressor diode (TVS) across the input terminal to protect the unit against surge or spike voltage and input reverse voltage (as shown).

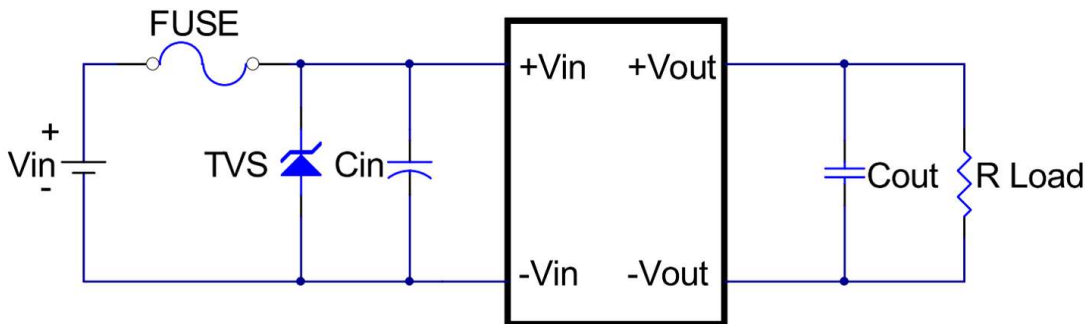

The external TVS & input capacitor (Cin) is required if EC7BW18-72 series has to meet EN61000-4-4 & EN61000-4-5. For testing EN50121-3-2 (railway), a TVS (SECOS SMDJ180A-C) & Cin (aluminum capacitor, 120uF/220V) are recommended.

For testing EN55035 (ITE), a TVS (SECOS SMDJ180A-C) & Cin (aluminum capacitor, 120uF/220V\*2pcs) are recommended.

### 9.2 EMC Considerations

EMI Test standard: EN55032 Class A, EN50121-3-2

Test Condition: Input Voltage: 110Vdc, Output Load: Full Load

(1) EMI meet EN55011/EN55032 / EN50121-3-2

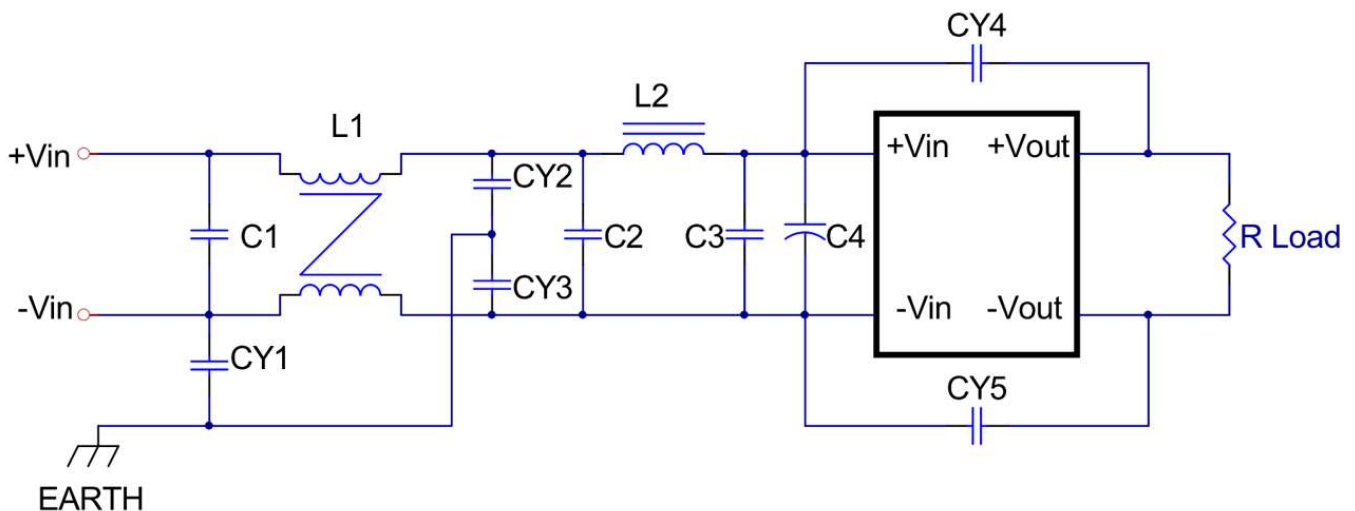



# EC7BW18 Series Application Note V14

Model Number	C1, C2, C3	C4	CY1	CY2, CY3	CY4, CY5	L1	L2
EC7BW18-72S05	1uF/250V 1812 Ceramic capacitor	120uF/220V KXJ Series Aluminum capacitor	680pF 400VAC Y1 capacitor	1500pF 400VAC Y1 capacitor	2200pF 400VAC Y1 capacitor	CMK-04 CINCON	10uH/7A 2525CZ Vishay
EC7BW18-72S12			470pF 400VAC Y1 capacitor				
EC7BW18-72S15							
EC7BW18-72D12							
EC7BW18-72D15							
EC7BW18-72D24							
Common Mode Choke Link						<a href="#">COMMON MODE CHOKE</a>	

Note:

C1, C2, C3: 1812 X7R ceramic capacitor.

C4: NIPPON CHEMI-CON KXJ series aluminum capacitor or equivalent.

CY1, CY2, CY3, CY4, CY5: TDK Y1 capacitor or equivalent.

L1: CMK-04 CINCON

L2: 10uH/7A 2525CZ VISHAY (G91B0904007).

## Input Conducted Emission (EN55032):

EC7BW18-72S05

Line

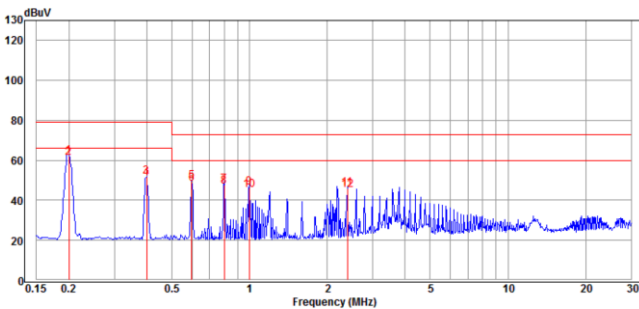

Neutral

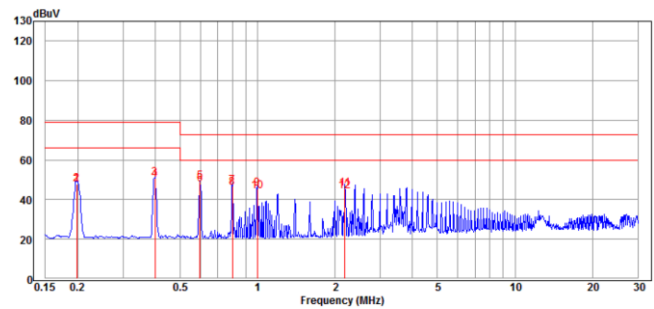

EC7BW18-72S12

Line

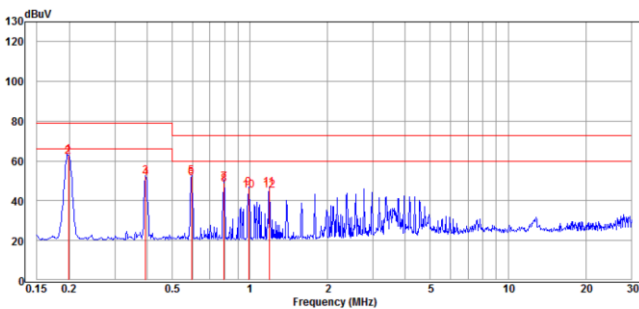

Neutral

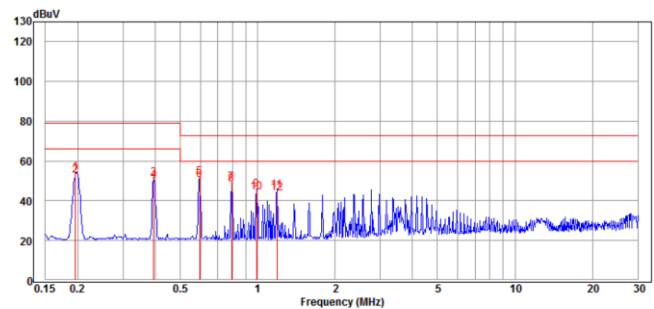



# EC7BW18 Series Application Note V14

## EC7BW18-72S15

Line

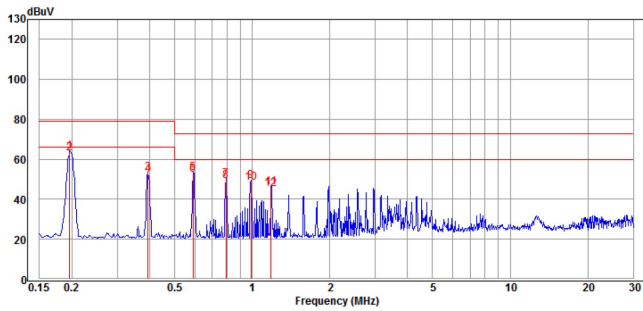

Neutral

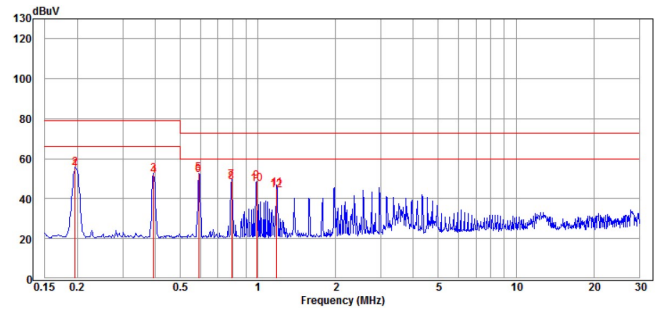

## EC7BW18-72D12

Line

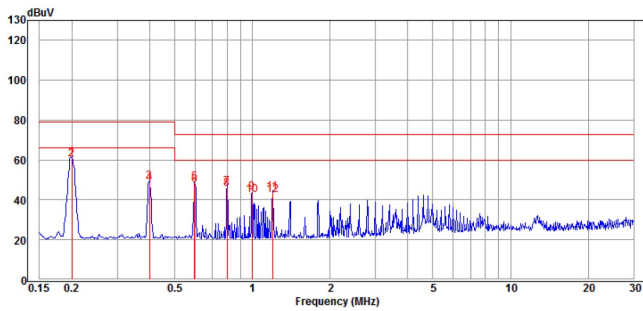

Neutral

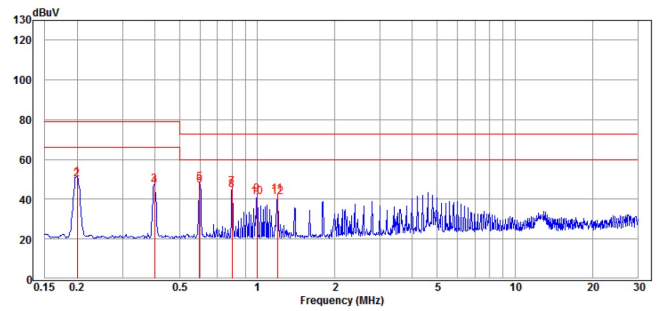

## EC7BW18-72D15

Line

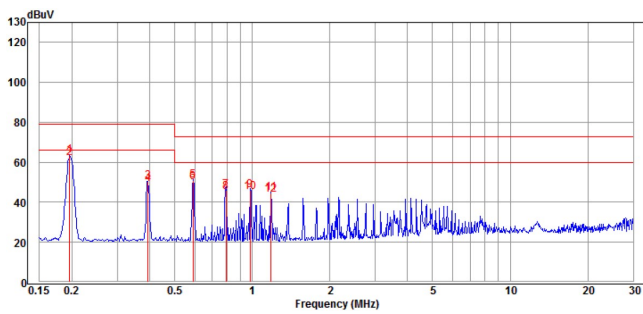

Neutral

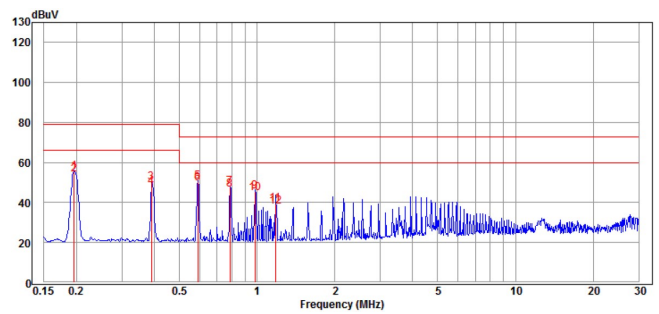

## EC7BW18-72D24

Line

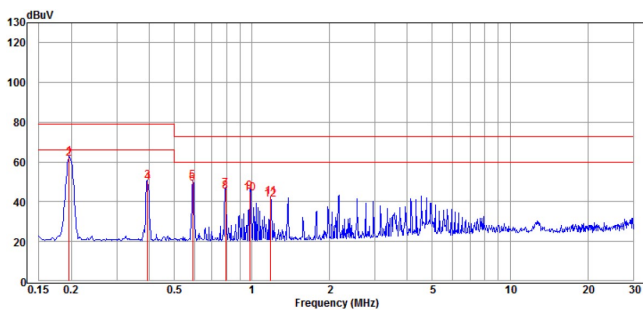

Neutral

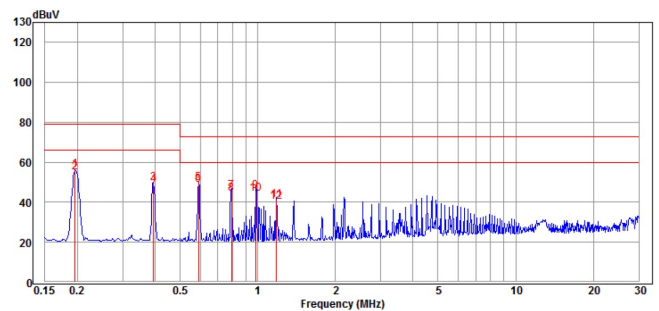



# EC7BW18 Series Application Note V14

## Input Conducted Emission (EN50121-3-2):

EC7BW18-72S05

Line

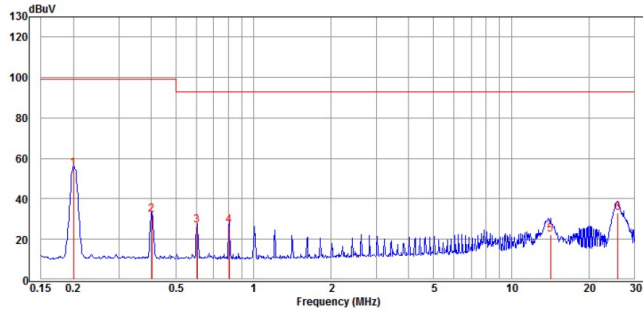

Neutral

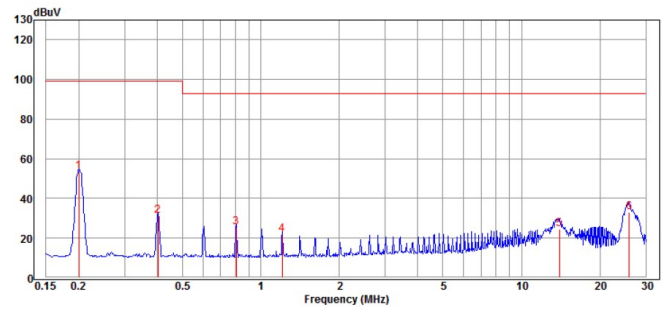

EC7BW18-72S12

Line

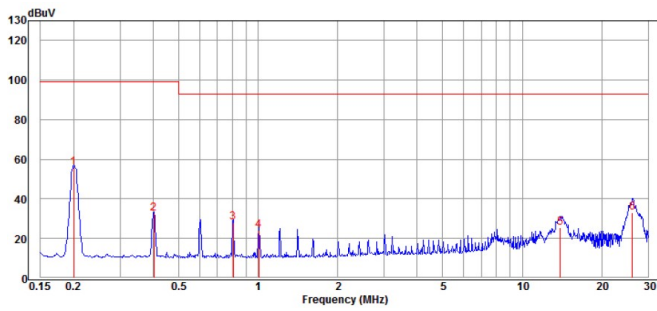

Neutral

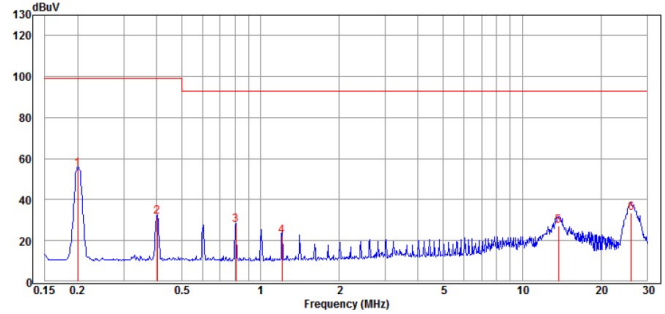

EC7BW18-72S15

Line

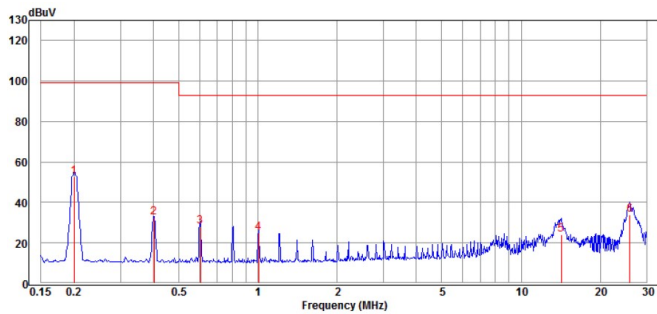

Neutral

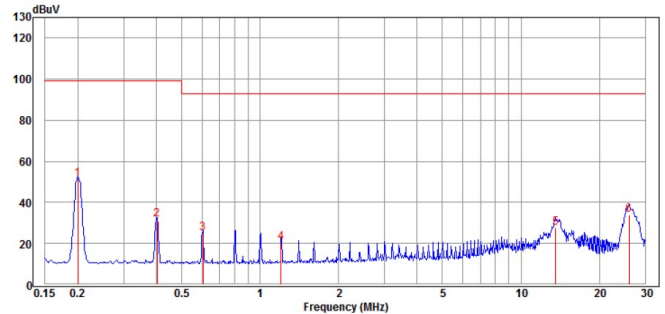

EC7BW18-72D12

Line

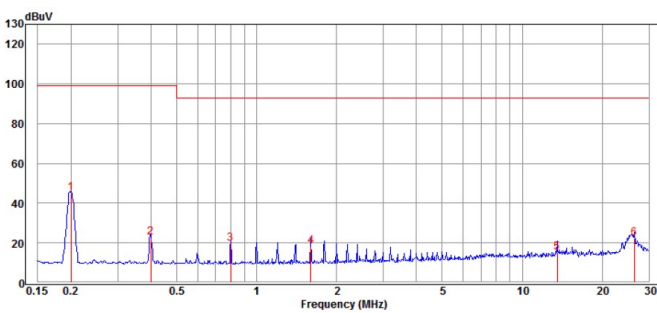

Neutral

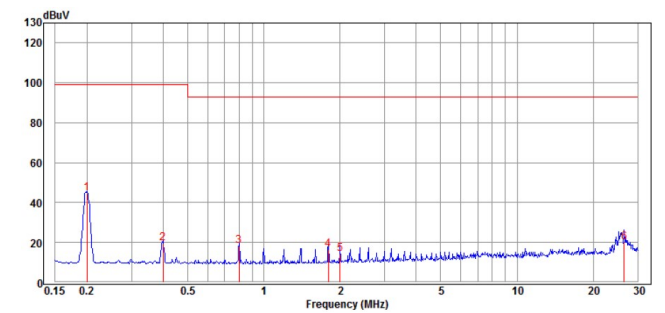



# EC7BW18 Series Application Note V14

## EC7BW18-72D15

Line

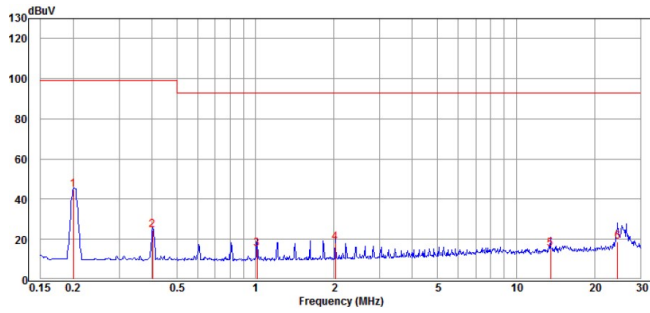

Neutral

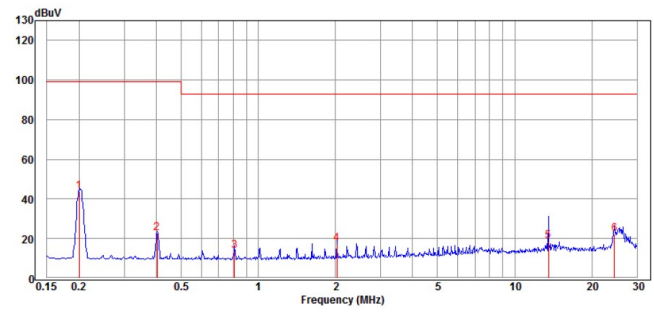

## EC7BW18-72D24

Line

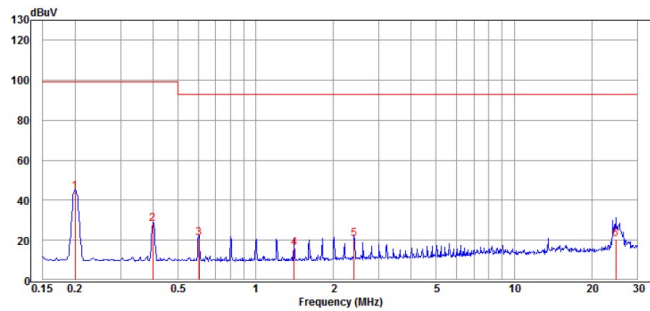

Neutral

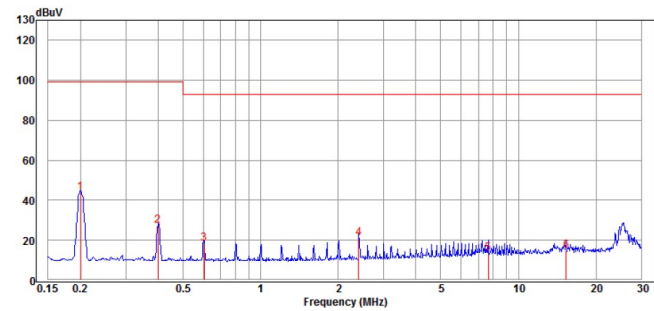

## Output Conducted Emission:

### EC7BW18-72S05

Positive

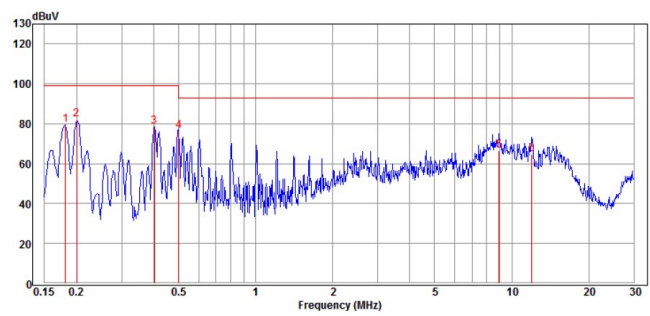

Negative

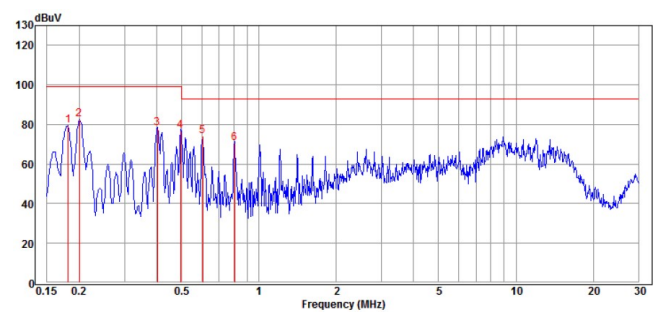

### EC7BW18-72S12

Positive

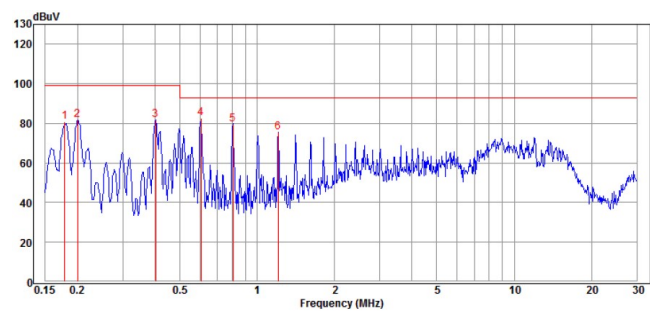

Negative

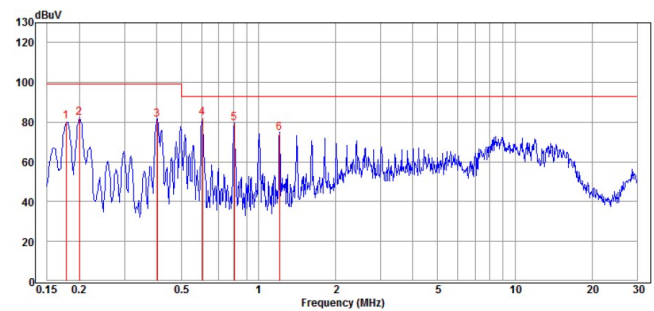





# EC7BW18 Series Application Note V14

## EC7BW18-72S15

Positive

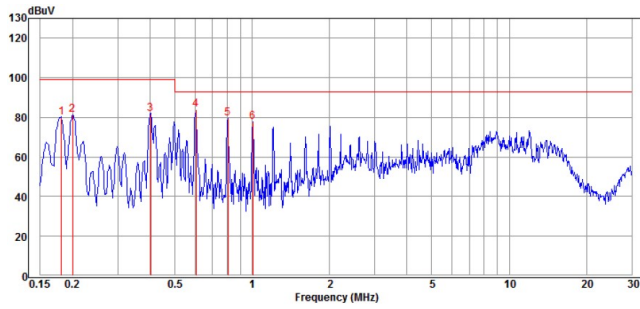

Negative

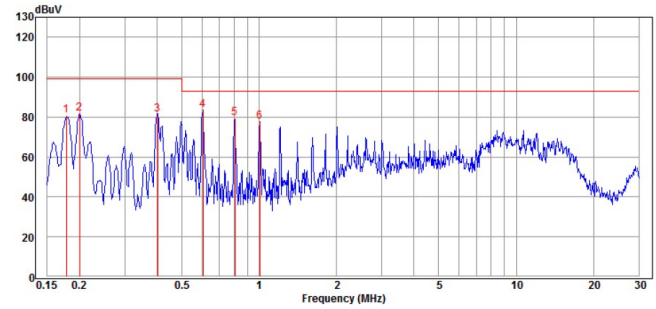

## EC7BW18-72D12

Positive

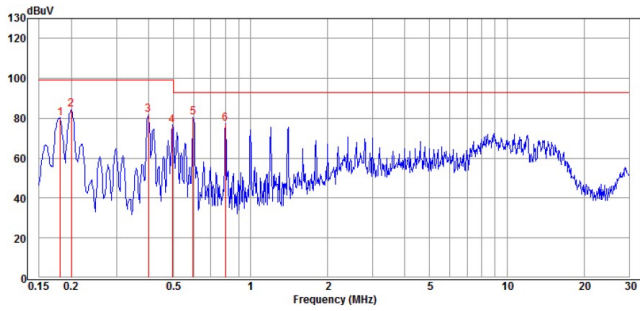

Negative

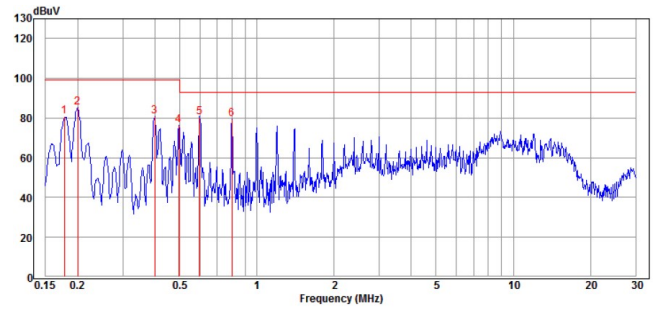

## EC7BW18-72D15

Positive

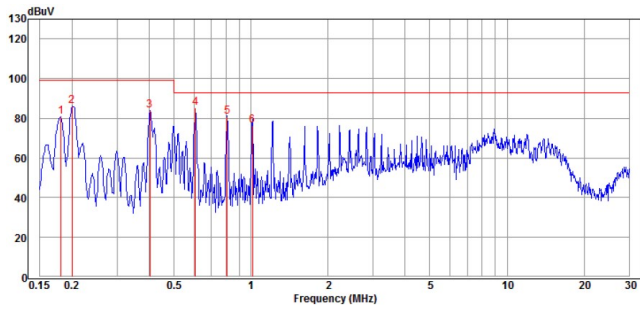

Negative

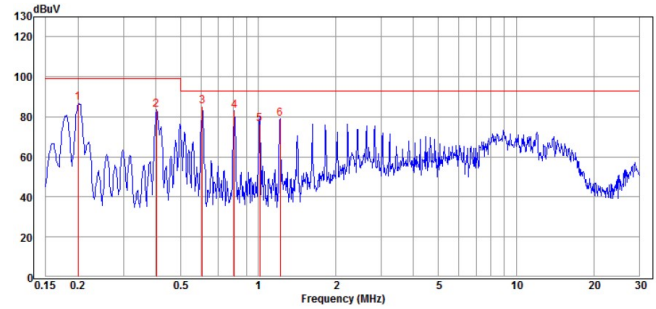

## EC7BW18-72D24

Positive

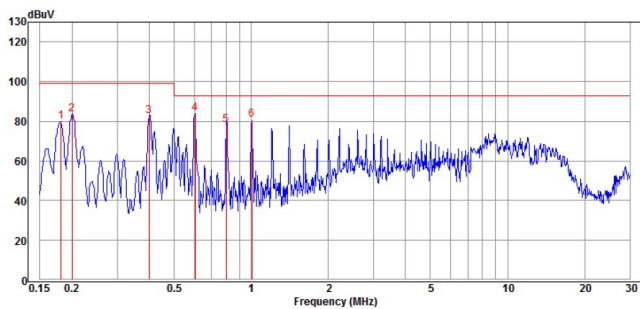

Negative

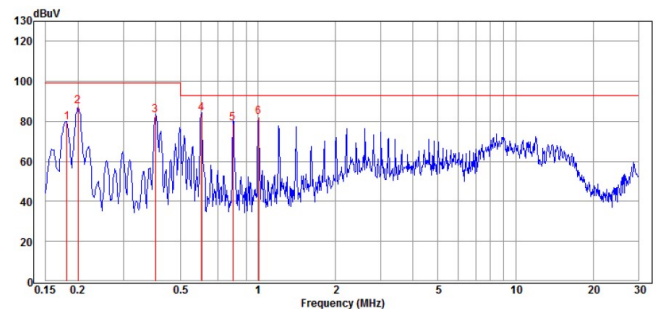



# EC7BW18 Series Application Note V14

## Radiated Emission (EN55032):

EC7BW18-72S05

Horizontal

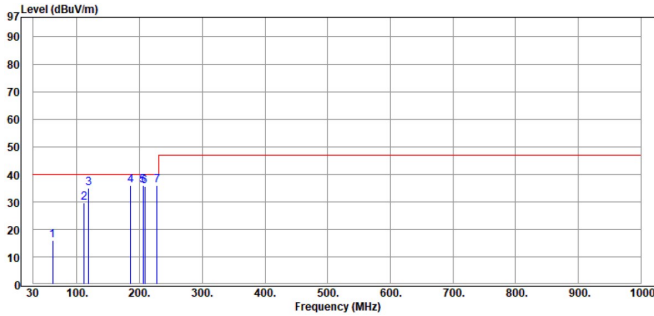

Vertical

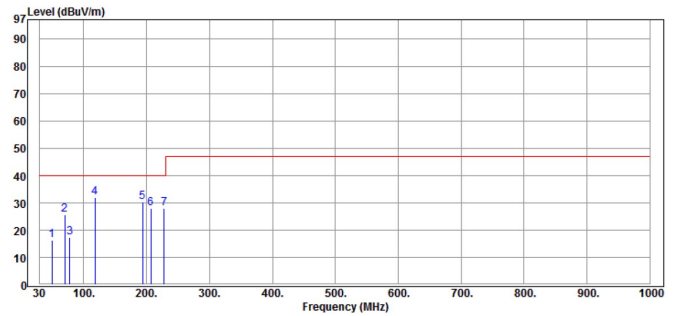

EC7BW18-72S12

Horizontal

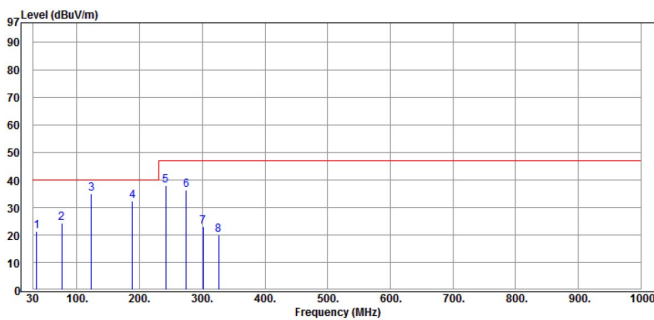

Vertical

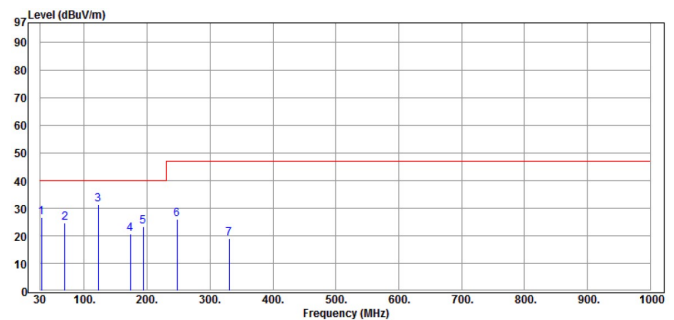

EC7BW18-72S15

Horizontal

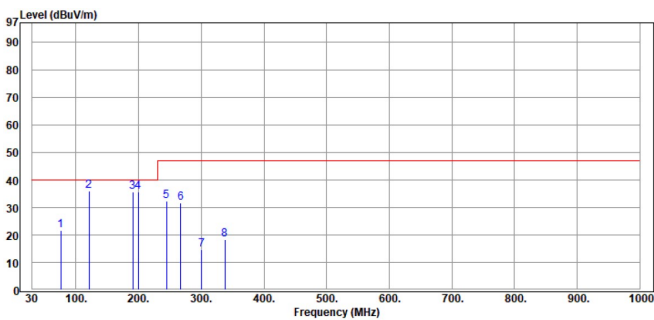

Vertical

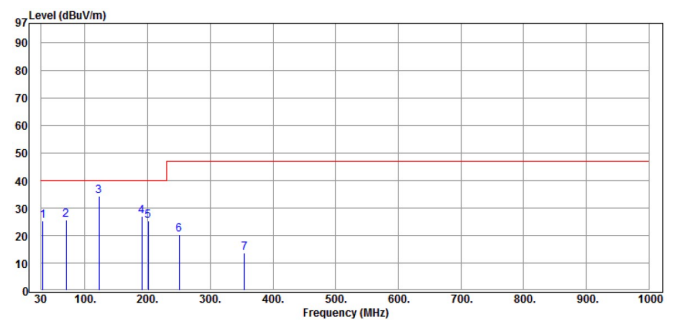

EC7BW18-72D12

Horizontal

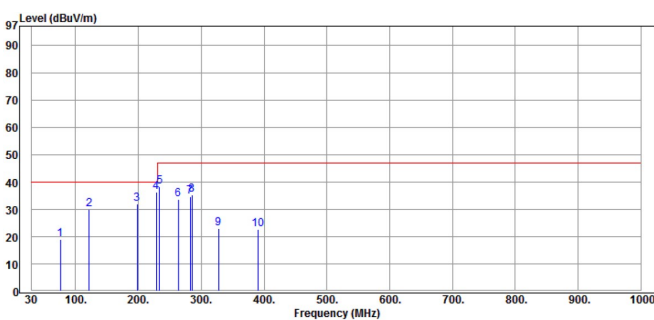

Vertical

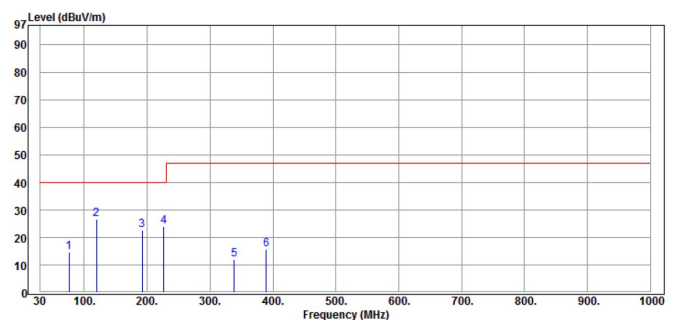



# EC7BW18 Series Application Note V14

## EC7BW18-72D15

Horizontal

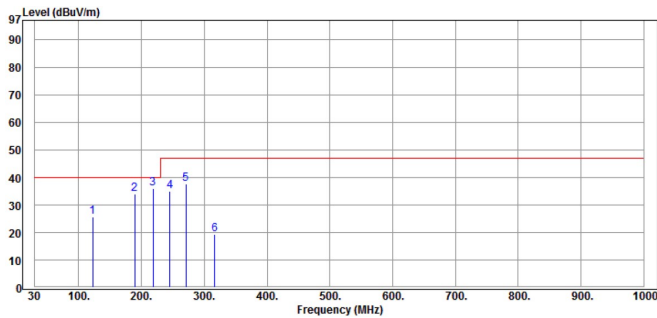

Vertical

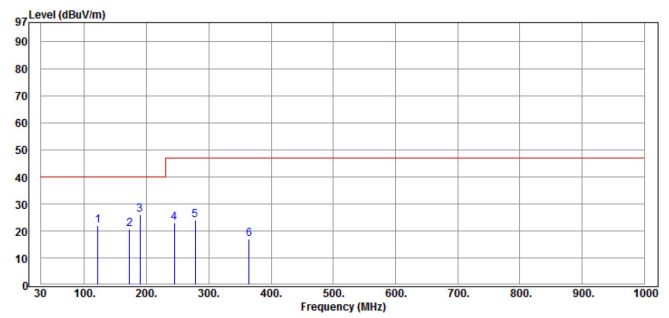

## EC7BW18-72D24

Horizontal

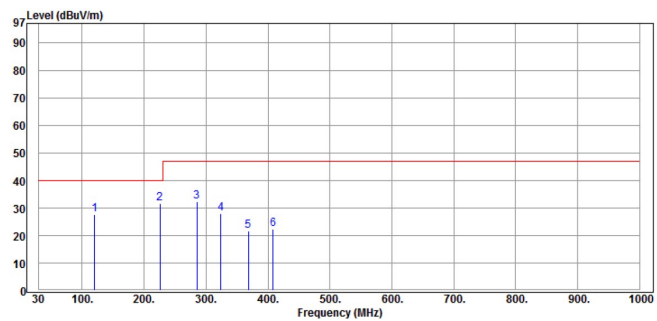

Vertical

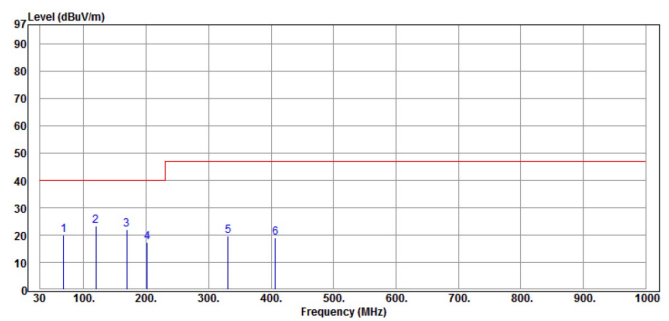

## Radiated Emission (EN50121-3-2):

### EC7BW18-72S05

Horizontal

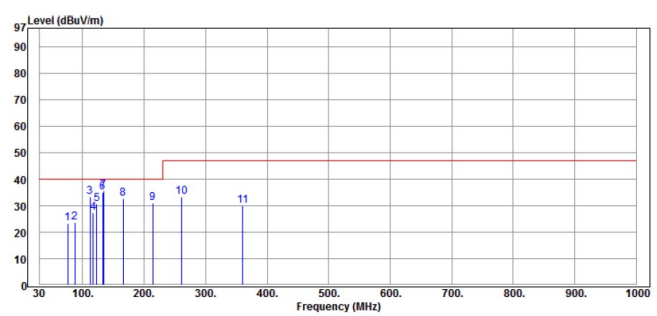

Vertical

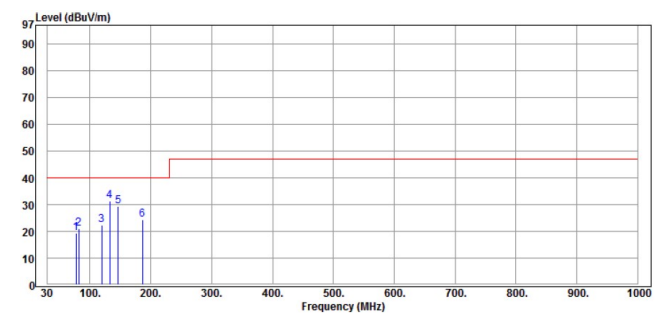

### EC7BW18-72S12

Horizontal

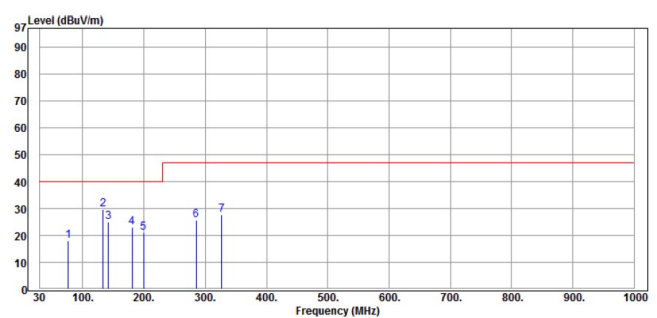

Vertical

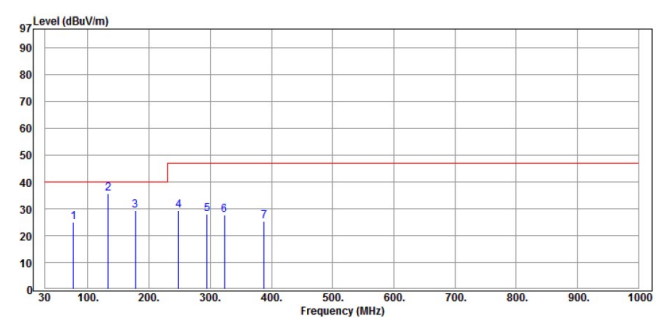



# EC7BW18 Series Application Note V14

## EC7BW18-72S15

Horizontal

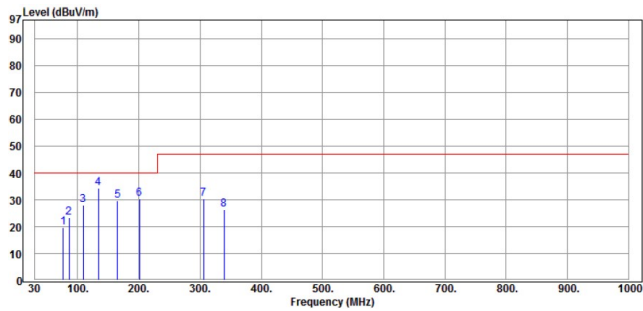

Vertical

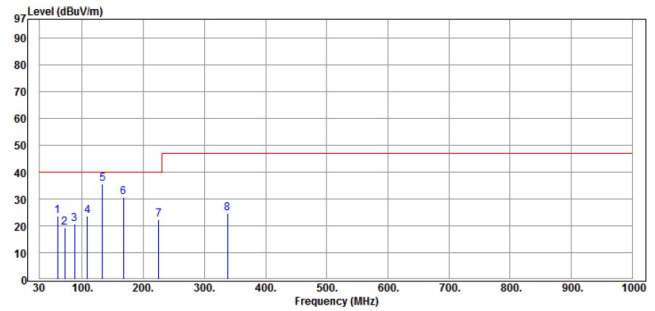

## EC7BW18-72D12

Horizontal

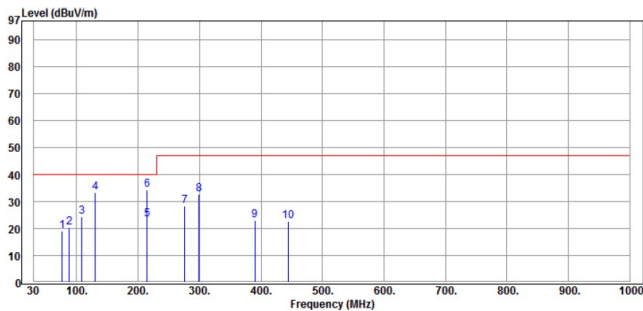

Vertical

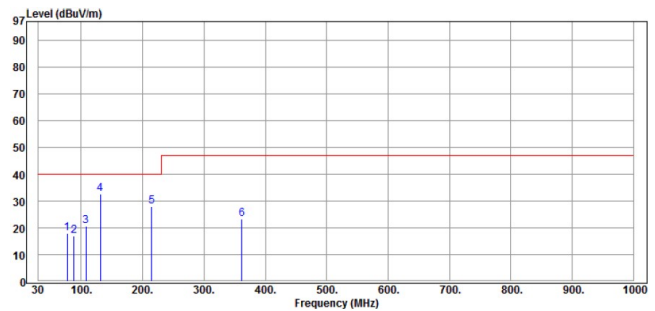

## EC7BW18-72D15

Horizontal

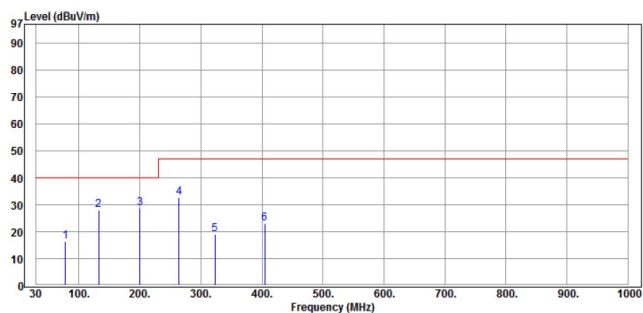

Vertical

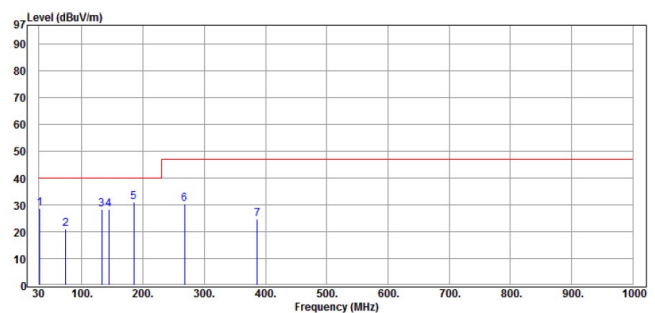

## EC7BW18-72D24

Horizontal

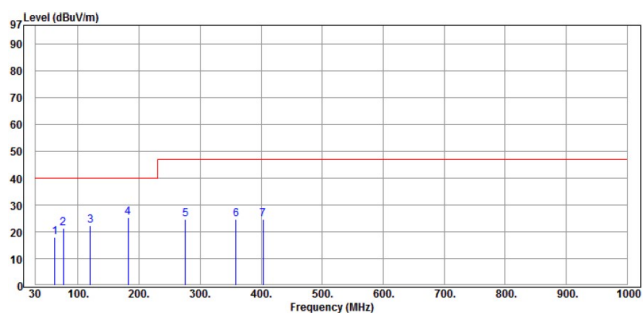

Vertical

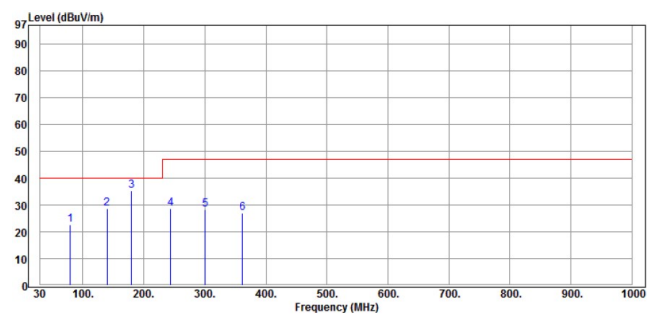



# EC7BW18 Series Application Note V14

## 9.3 Suggested Configuration for RIA12 Surge Test

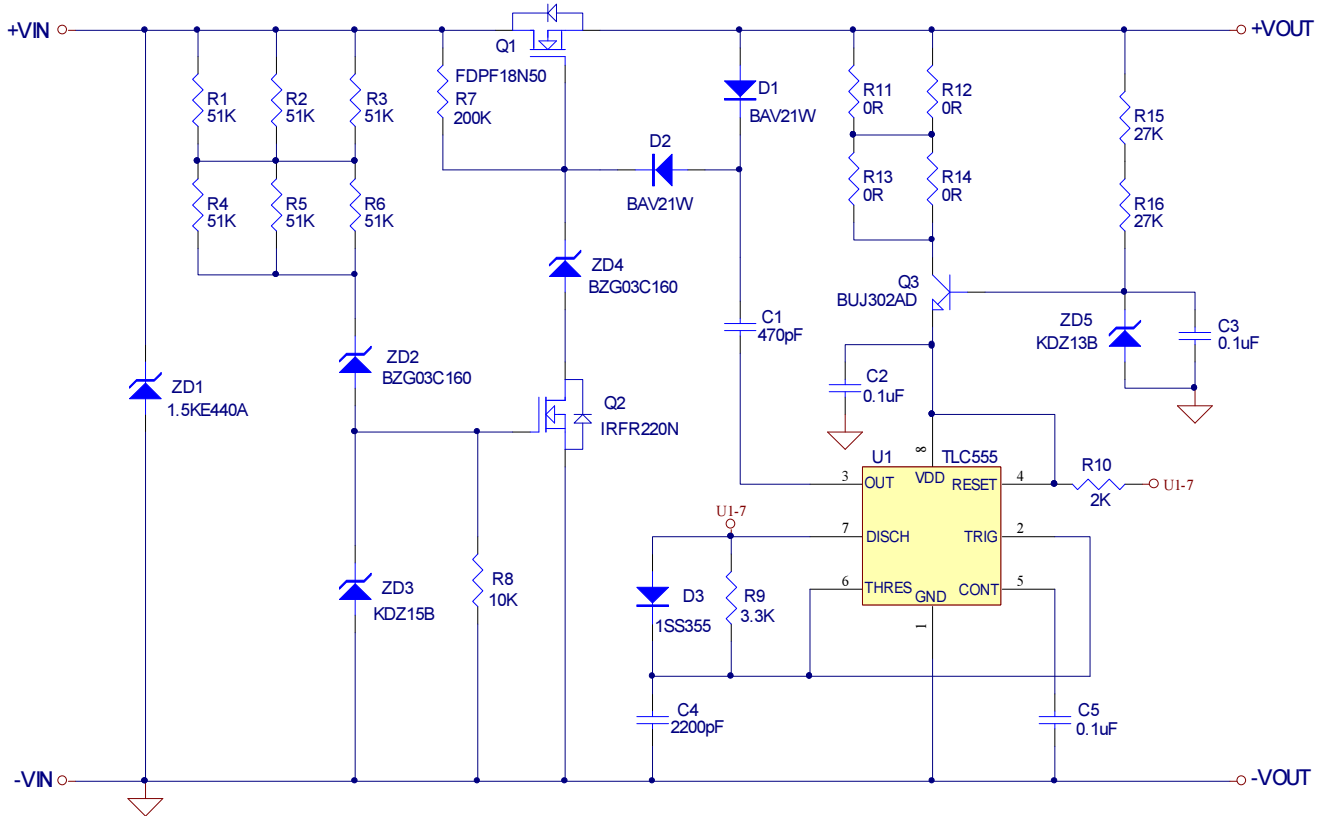

Note: Q1 suggest use FDPF18N50 or equivalent and provide good heat dissipation condition

### CINCON ELECTRONICS CO., LTD.

#### Headquarters:

14F, No.306, Sec.4, Hsin Yi Rd.  
Taipei, Taiwan  
Tel: 886-2-27086210  
Fax: 886-2-27029852  
E-mail: [sales@cincon.com.tw](mailto:sales@cincon.com.tw)  
Web Site: <https://www.cincon.com>

#### Factory:

No. 8-1, Fu Kung Rd.  
Fu Hsing Industrial Park  
Fu Hsing Hsiang,  
ChangHua Hsien, Taiwan  
Tel: 886-4-7690261  
Fax: 886-4-7698031

#### Cincon North America:

1655Mesa Verde Ave. Ste 180  
Ventura, CA93003  
Tel: 805-639-3350  
Fax: 805-639-4101  
E-mail: [info@cincon.com](mailto:info@cincon.com)