

SC connector for 200/230µm PCF with zirconia ferrule

1 General _____

The “SC” connector is especially optimised for FO applications with 200/230µm PCF, which require quick and easy termination with very good mechanical and optical properties.

2 Application _____

Due to the very good optical characteristics and easy termination technique, these connectors are suitable for different applications:

- optical networks
- industry electronics
- power electronics
- consumer electronics



Pic. 1 SC connector

4 Ordering information _____

SC connector for 200/230µm PCF with zirconia ferrule (crimp sleeve and bend protection not included)

Specification	Part number
SC connector zirconia ferrule	902SS230SC022-03

3 Dimensionend drawing _____

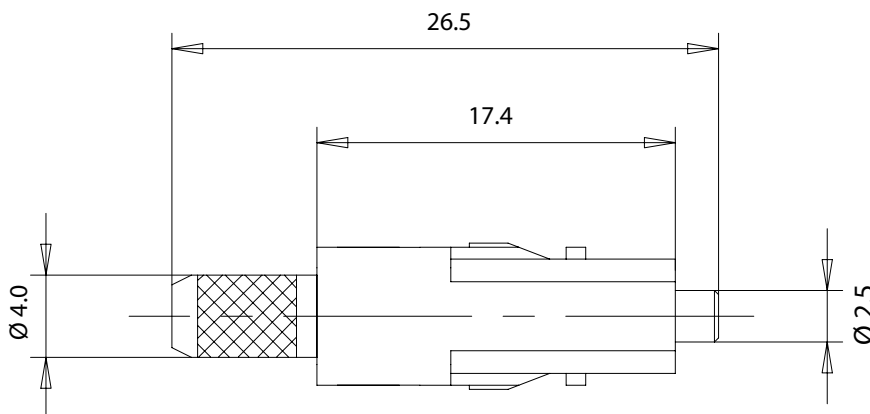

Pic. 2 Dimensions SC contact

SC connector for 200/230µm PCF with zirconia ferrule

5 Cable assembly

The following tools and materials are recommended for easy and reliable 200/230 µm PCF cable termination with SC connector:

Crimping tool hexagonal	910CZ00100008
Fiber stripper 0.3 mm	910AB00130001
Cleaving tool	910FRW0100001
Epoxy mix	9102KKFERTIG1
One-way syringe with needle	910SPRITZ0001
Polishing film 5 µm	910PB00105001
Polishing film 1 µm	910PB00101001
Heat oven	910AO00100001
Polishing disc	910PS0SC00001
Microscope 100x	910MIKRO10002
Adapter	910MIADAST002

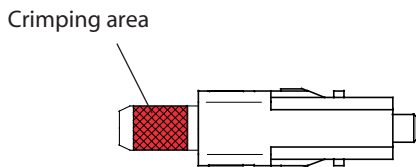

Pic. 3 SC contact crimping area

5.1 FO cable

Strip the cable according to the measures mentioned below (Pic. 4) at minimum 50 mm, then cut down the aramid yarn/kevlar to 6 mm and strip the fiber. Remove the 0.5 mm coating with stripping tool 0.3 mm. Clean off gel residuals with a wipe.

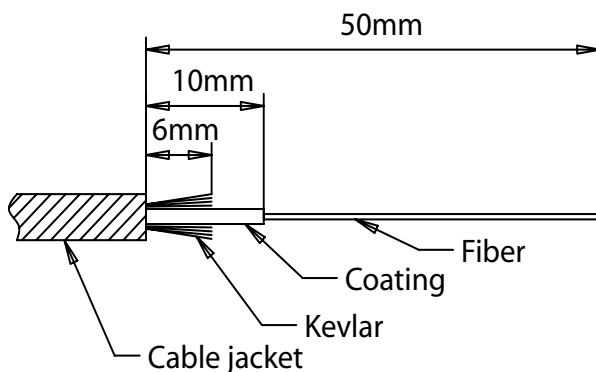

Pic. 4 Stripping dimensions

5.2 Pasting

Compound the epoxy mix and fill it into the one-way syringe. Then fill the SC connector contact from the cable side with two drops (Ø 2mm) (Pic. 5).

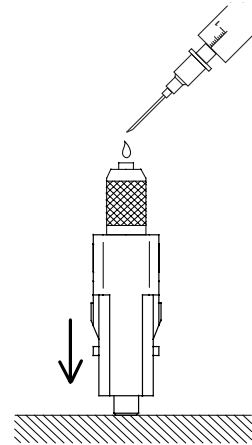

Pic. 5 Filling epoxy mix into SC contact

It is recommended to press down the SC contact on a clean plastic base, thus pushes the inner tube which can be filled with epoxy. Avoid adhesives on the outside of the tube that can cause fracture of fiber after curing.

5.3 Fiber crimping

Push the crimp sleeve and the bend protection boot upon the cable. After that push the stripped fiber and the cable into the connector up to the end stop. The fiber has to stick out of the ferrule. Afterwards push the crimp sleeve over the kevlar/aramid yarn to the end stop upon the connector (Pic. 6).

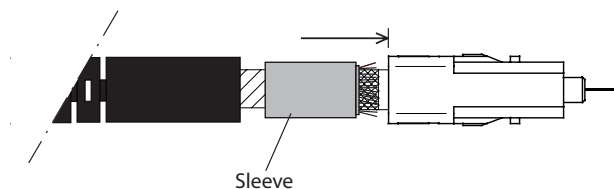

Pic. 6 SC contact with crimp sleeve and bend protection

SC connector for 200/230µm PCF with zirconia ferrule

Crimp the sleeve with the allen crimping tool (spanner size 4.95) over the total length and push the bend protection boot onto the sleeve.



Pic. 7 Crimping tool hexagonal

Have the epoxy in the SC contact cured in the heat oven (curing time: min. 1 hour at 70°).

After curing take the contact out off the oven and cleave the protruding fiber min. 1 mm to the end of the ferrule with the cleaving tool (Pic. 8). Using a gentle straight pull to remove the exposed fiber.

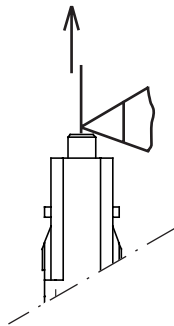

Pic. 8 Cleaving fiber

5.4 Fiber endface treatment

First grind off the remaining exposed fiber with 5 µm paper using extremely light pressure (Pic. 9).

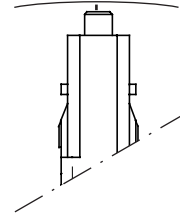

Pic. 9 Grinding fiber with polishing film

Put the connector into the polishing disk (Pic. 10) and polish it with polishing paper 1 µm on a hard base (glass plate) for flat polish or on a flexible pad (e.g. rubber base) to get a convex polishing.

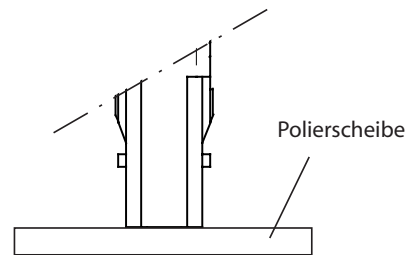

Pic. 10 SC contact with polishing disc

- Check the quality of the fiber surface with the microscope.
- Repeat polishing on 1µm if fiber endface is not clean or free of scratches.
- After polishing please wipe off the residuals of polishing.
- Push the grip plates over the contact until it snaps in.
- Please note the keying of the housing.
- As last step push the ready made SC connector into the duplex housing until it snaps in.

The information released by Ratioplast-Optoelectronics GmbH in this data sheet is believed to be accurate and reliable. However, no responsibility is assumed by Ratioplast-Optoelectronics GmbH for its use. Ratioplast-Optoelectronics GmbH reserves the right to change circuitry and specifications at any time without notification to the customer.