

## HIG48VDC

- Insulation monitoring devices HIG\*VDC(-L) are designed for the monitoring of the insulation status of DC IT systems with nominal voltage 12, 24, 48, 72 or 110 V DC.
- The device continuously monitors the insulation status of both branches of the isolated IT system against a reference point. For stationary equipment this is usually the PE conductor, for mobile equipment it is the vehicle frame.
- If the insulation condition in the positive branch R+ or negative branch R- is faulty, this condition is signalled by setting relay KA1/KA2. The fault condition is also indicated by LEDs on the front panel.
- These devices are equipped with a display for showing the currently measured values. The display, together with the buttons is also used to set the device.
- HIG24VDC(-L)/T, HIG48VDC(-L)/T, HIG72VDC(-L)/T, HIG110VDC(-L)/T are designed for railway use (EN 50155) to monitor the insulation condition of DC IT systems.

Type		HIG48VDC
Monitored IT power supply system type according to IEC 61557-8		DC
Measuring range of insulation resistance	$R_F$	5 ÷ 990 kΩ
Adjustable range of critical insulation resistance	$R_{an}$	5 ÷ 500 kΩ
Number of insulation resistance fault levels ( $R_{an}$ )		1
Rated voltage of monitored IT system (DC)	$U_n$	48 V
Nominal supply voltage DC	$U_s$	32 ÷ 60 V
IMD power supply		From measured IT system
Power consumption	P	2 VA
Measuring input's internal impedance	$Z_i$	> 120 kΩ
Internal DC resistance	$R_i$	> 120 kΩ
Measuring accuracy		± 10 %
Equipped with display		Yes (OLED technology)
Supported module of remote monitoring panels (MDS)		MDS-D, MDS-DELTA
Communication interface for user		RS485 bus
Communication protocol		ISOLGUARD
External control inputs		Test start, Deblocking function
Housing material		Polyamid PA6, UL94 V-0
Electrical strength against internal circuits		3 750 V
Degree of protection of front panel		IP40
Degree of protection except the front panel		IP20
Operating temperature	θ	-25 ÷ 70 °C
Storage temperature		-40 ÷ 70 °C
Protection class according to IEC 61140		II
Recommended cross-section of connecting wires	S	1 mm <sup>2</sup>
Installation		On DIN rail 35 mm
Modular width		2 TE

Type		HIG48VDC
Width		36 mm
Height		90 mm
Depth		63.5 mm
Recommended fuse protection		6 A/gG
Use for traction		No
Operating position		Any
Operation type		Permanent
<b>Designed according to standards</b>		
Insulation monitoring devices for IT systems		IEC 61557-8:2014
Equipment for testing, measuring or monitoring of protective measures		IEC 61557-1:2007
Insulation coordination for equipment within low-voltage systems		IEC 60664-1:2007
Railway applications – Rolling stock – Electronic equipment		EN 50155:2017
Railway applications – Rolling stock equipment – Shock and vibration tests		IEC 61373:2010
Railway applications – Fire protection on railway vehicles		EN 45545-2:2013
Railway applications – Electromagnetic compatibility		EN 50121-3-2:2016
<b>Application standards</b>		
Low-voltage electrical installations – Protection against electric shock		HD 60364-4-41:2017
<b>Ordering, packaging and additional data</b>		
Mass	m	124 g
Mass (including the packaging)	m	138 g
Packaging dimensions (H x W x D)		45 x 102 x 74 mm
Packaging value	V	0.34 dm <sup>3</sup>
Customs tariff no.		90303370
EAN code		8590681709351
<b>Art. number</b>		<b>70 935</b>



The link in the QR code leads to the online presentation of the HIG48VDC.

There, in addition to the always up-to-date data sheet, you will also find all diagrams and drawings, declarations of conformity, or 2D or 3D models and other necessary materials. For more information, visit [www.hakel.com](http://www.hakel.com)



8590681709351

## Application wiring diagram (installation) 1/2

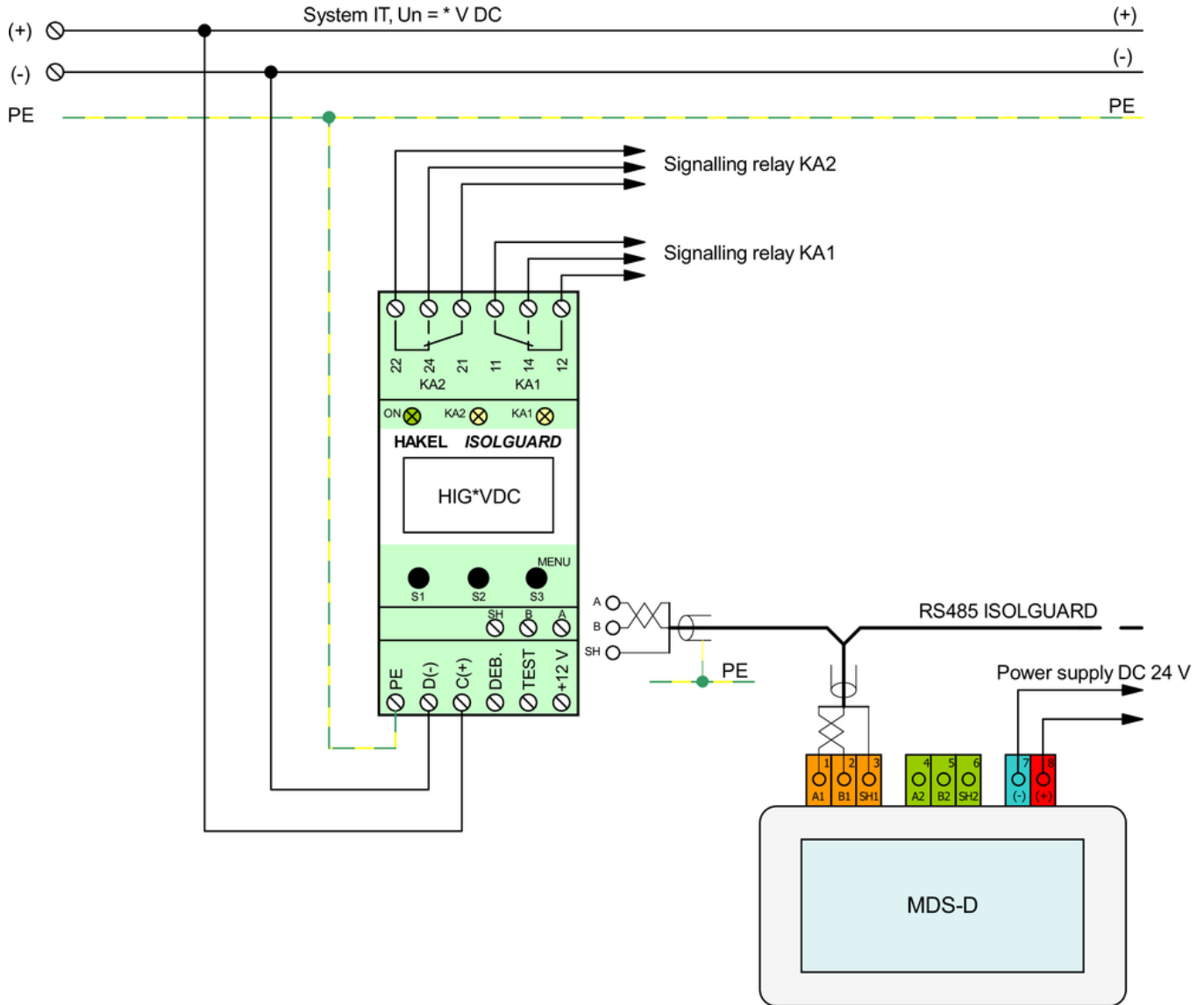

## Application wiring diagram (installation) 2/2

