

TL 500

- The coupling devices TL* are used to adapt the input circuits of the insulation monitoring device to a higher operating voltage than the operating voltage of the IMD directly.
- The coupling units are connected between IT power supply system and insulation monitoring device.

Type		TL 500
Rated operating AC voltage	U_N	500 V
Maximum continuous operating voltage AC	U_C	600 V
Designed for an insulation monitoring device		HIS71, HIG95, HIG97, HIG93, HIG91, HIG92, HIG94
Maximal operating current AC	I_C	< 3 x 0.1 mA
Internal resistance	R_{IN}	3 x 12,7 k Ω
Internal inductance	L_{IN}	3 x 330 H
Offset for insulation monitoring device	$R_{tl\ ext}$	4.4 k Ω
Housing material		Polyamid PA6, UL94 V-0
Degree of protection		IP20
Operating temperature	ϑ	-25 \div 55 $^{\circ}$ C
Recommended cross-section of connecting wires	S	1.5 mm ²
Tightening torque		0.2 Nm
Installation		On DIN rail 35 mm
Modular width		2 TE
Operating position		Any
Operation type		Permanent
Lifetime		> 100 000 h
Use for traction		No
Designed according to standards		
Insulation coordination for equipment within low-voltage systems		IEC 60664-1:2007
Safety of power transformers, power supplies, reactors and similar		IEC 61558-1:2005
Ordering, packaging and additional data		
Mass	m	310 g
Mass (including the packaging)	m	324 g
Packaging dimensions (H x W x D)		45 x 102 x 74 mm
Packaging value	V	0.34 dm ³
Customs tariff no.		90303370
EAN code		8590681705018
Art. number		70 501



The link in the QR code leads to the online presentation of the TL 500. There, in addition to the always up-to-date data sheet, you will also find all diagrams and drawings, declarations of conformity, or 2D or 3D models and other necessary materials. For more information, visit www.hakel.com



Application wiring diagram (installation)

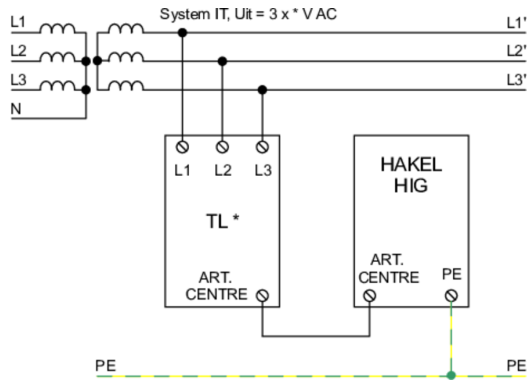

Internal diagram

